

PowerEdge R710



Technical Guide



The Dell PowerEdge R710, with the performance of Intel® Xeon® processors, offers you a 2U rack server to efficiently address a wide range of key business applications.

This document is for informational purposes only. Dell reserves the right to make changes without further notice to any products herein. The content provided is as is and without express or implied warranties of any kind.

Dell, PowerEdge, and ReadyRails are trademarks of Dell, Inc. Citrix is a registered trademark and XenServer is a trademark of Citrix Systems, Inc. and/or one or more of its subsidiaries, and may be registered in the United States Patent and Trademark Office and in other countries. Intel and Xeon are registered trademarks of Intel Corporation in the U.S. and other countries. Broadcom is a registered trademark and NetXtreme is a trademark of Broadcom Corporation and/or its affiliates in the United States, certain other countries and/or the EU. Matrox is a registered trademark of Matrox Electronic Systems Ltd. Microsoft and SQL Server are either registered trademarks or trademarks of Microsoft Corporation in the United States and/or other countries. Red Hat is a registered trademark of Red Hat, Inc. in the United States and other countries. Linux is a registered trademark of Linus Torvalds. Symantec and Altiris are trademarks owned by Symantec Corporation or its affiliates in the U.S. and other countries. VMware is a registered trademark and vSphere is a trademark of VMware, Inc. in the United States and/or other jurisdictions. Other trademarks and trade names may be used in this document to refer to either the entities claiming the marks and names or their products. Dell disclaims proprietary interest in the marks and names of others.

©Copyright 2011 Dell Inc. All rights reserved. Reproduction or translation of any part of this work beyond that permitted by U.S. copyright laws without the written permission of Dell Inc. is unlawful and strictly forbidden.

Revision 1 January 2011

Table of Contents

1	Product Comparison	7
1.1	Overview	7
1.1.1	Strong IT Foundation.....	7
1.1.2	Customer-Inspired Design	7
1.1.3	Enhanced Virtualization	7
1.1.4	Energy Efficient	7
1.1.5	Easy to Manage	8
1.1.6	Dell Services	8
1.2	Comparison	8
2	Key Technologies.....	11
2.1	Overview	11
2.2	Detailed Information	11
3	System Overview	12
4	Mechanical	15
4.1	Chassis Description.....	15
4.2	Dimensions and Weight.....	15
4.3	Front Panel View and Features	15
4.4	Back Panel View and Features	16
4.5	Power Supply Indicators.....	16
4.6	NIC Indicators.....	17
4.7	Internal Chassis Views	17
4.8	Rails and Cable Management	18
4.8.1	ReadyRails Sliding Rails	18
4.8.2	ReadyRails Static Rails	19
4.9	Fans	19
4.10	LCD Control Panel.....	19
4.11	Security	20
4.11.1	Cover Latch	20
4.11.2	Bezel	20
4.11.3	Hard Drive	20
4.11.4	TPM.....	21
4.11.5	Power Off Security	21
4.11.6	Intrusion Alert	21
4.11.7	Secure Mode	21
4.12	USB Key	21
4.13	Battery.....	21
4.14	Field Replaceable Units (FRU).....	21
4.15	User Accessible Jumpers, Sockets, and Connectors.....	21
5	Power, Thermal, Acoustic	22
5.1	Power Efficiency	22
5.2	Main Power Supply	22
5.3	Power Supply Specifications.....	23
5.4	Heat Dissipation	23
5.5	Environmental Specifications.....	23
5.6	Power Consumption Testing	24
5.7	Maximum Input Amps	25
5.8	Energy Smart Enablement	25
5.9	Energy Star Compliance	25
5.10	Acoustics	25

6	Processors	27
6.1	Overview	27
6.2	Features	28
6.3	Supported Processors	28
6.4	Processor Configurations	29
6.4.1	Single Processor Configuration	29
6.4.2	Processor Power Voltage Regulation Modules (EVRD 11.1)	29
6.5	Processor Installation	29
7	Memory	30
7.1	Overview	30
7.2	DIMMs Supported	30
7.2.1	Memory Modes	30
7.2.2	DIMM Population Rules	31
7.3	Speed	31
7.4	DIMM Slots	32
7.5	Low Voltage DIMMs	32
7.6	Mirroring	32
7.7	Sparing	33
7.8	Memory Scrubbing	33
7.9	Advanced ECC (Lockstep) Mode	33
7.10	Optimizer (Independent Channel) Mode	33
7.11	Supported Configurations	33
8	Chipset	34
8.1	Overview	34
8.1.1	Intel I/O Hub (IOH)	34
8.1.2	IOH QuickPath Interconnect (QPI)	34
8.1.3	IOH PCI Express	34
8.1.4	Intel I/O Controller Hub 9 (ICH9)	34
9	BIOS	36
9.1	Overview	36
9.2	Supported ACPI States	36
9.3	I ² C (Inter-Integrated Circuit)	36
10	Embedded NICs/LAN on Motherboard (LOM)	38
11	PCI Slots	39
11.1	Overview	39
11.2	PCI Express Risers	39
11.3	Express Card Specifications (x16)	39
11.4	Quantities and Priorities	39
11.5	PCI Card Dimensions	40
12	Storage	41
12.1	Overview	41
12.2	Internal Hard Disk Drives	41
12.2.1	Diskless Configuration Support	42
12.2.2	Hard Drive LED Indicators	42
12.3	RAID Configurations	42
12.4	Storage Controllers	44
12.4.1	SAS 6/iR	44
12.4.2	PERC 6/i	44
12.4.3	PERC H200	44
12.4.4	PERC H700	45
12.5	Optical Drives	46
12.6	Tape Drives	46

Dell

12.7	External Storage Support	46
13	Video.....	47
14	Rack Information.....	48
14.1	Overview	48
14.2	Rails.....	48
14.3	Cable Management Arm (CMA).....	50
14.4	Rack View	50
15	Operating Systems	53
16	Systems Management.....	54
16.1	Overview	54
16.2	Server Management.....	54
16.3	Embedded Server Management	55
16.4	Dell Lifecycle Controller and Unified Server Configurator	55
16.5	Integrated Dell Remote Access Controller.....	55
16.6	iDRAC6 Express	56
16.7	iDRAC6 Enterprise.....	56
16.8	iDRAC6 Enterprise with Virtual Flash (vFlash) Media	56
17	USB Peripherals	59
Appendix A.	Certifications	60
A.1	Regulatory Certifications	60
A.2	Product Safety Certifications.....	60
A.3	Electromagnetic Compatibility.....	61
A.4	Ergonomics, Acoustics and Hygienics	61
Appendix B.	Additional Information and Options	62

Tables

Table 1.	Feature Comparison to PowerEdge R610 and R810.....	8
Table 2.	Product Features Summary	12
Table 3.	Power Supply Status	17
Table 4.	Power Supply Specifications.....	23
Table 5.	Environmental Specifications.....	23
Table 6.	Power Consumption Testing	24
Table 7.	Acoustical Performance	25
Table 8.	Intel Xeon 5500 and 5600 Processor Series Features.....	27
Table 9.	Supported Processors	28
Table 10.	Supported Hard Drives.....	41
Table 11.	Factory RAID Configurations.....	42
Table 12.	Storage Card Support Matrix.....	45
Table 13.	Graphics Video Modes	47
Table 14.	Supported Racks.....	49
Table 15.	Rail Adjustability Ranges and Depth	50
Table 16.	Unified Server Configurator Features and Description.....	55
Table 17.	Features List for Base Management Functionality, iDRAC, and vFlash	57
Table 18.	Product Safety Certifications.....	60
Table 19.	Electromagnetic Compatibility Certifications.....	61
Table 20.	Ergonomics, Acoustics and Hygienics.....	61
Table 21.	Industry Standards	62

Figures

Figure 1.	Chassis Dimensions	15
Figure 2.	Front View (3.5” Hard Drive Chassis)	16
Figure 3.	Front View (2.5” Hard Drive Chassis)	16
Figure 4.	Front View (With Optional Bezel)	16
Figure 5.	Back View	16
Figure 6.	Internal Chassis View	18
Figure 7.	Fan Gantry	19
Figure 8.	Control Panel	20
Figure 9.	Power Supplies	23
Figure 10.	Memory Channels	31
Figure 11.	R710 Sliding Rails with Optional CMA	48
Figure 12.	2U Threaded Rack Adapter Brackets Kit	49
Figure 13.	R710 Static Rails	49
Figure 14.	R710 Mounted in B1 Sliding Rails	51
Figure 15.	R710 Mounted in the B1 Sliding Rails with the CMA	51
Figure 16.	R710 Mounted in the A2 Static Rails (2-post Center Mount Configuration)	52

1 Product Comparison

1.1 Overview

The Dell™ PowerEdge™ R710 is a 2-socket 2U rack server that can help you operate efficiently and lower total cost of ownership (TCO) with enhanced virtualization capabilities, improved energy efficiency, and innovative system management tools.

1.1.1 Strong IT Foundation

You want a data center built for organic growth and the ability to scale based on your company's changing requirements. You need complete solutions that let you focus your time and money on managing and growing your business. Dell responds with an expanding portfolio of enterprise servers, storage technologies, and services with a single goal: to help you simplify IT. The PowerEdge R710 is designed for versatility and high performance, providing many of the virtualization, system management, and energy-efficiency features you need now with the necessary scalability to change as your business grows.

1.1.2 Customer-Inspired Design

Dell PowerEdge 11th generation servers are designed to meet customer needs with excellent reliability, security, and commonality, making your experience easier. With Dell's system commonality, once your IT managers learn one system, they understand how to manage next-generation Dell servers. Logical component layout and power supply placement provide a straightforward installation and redeployment experience. The PowerEdge R710 provides an interactive LCD for alerting and control of basic management. The LCD also provides system health monitoring and checks the AC power meter and ambient temperature monitor that is included with each server. The PowerEdge R710 features robust metal hard drive carriers and organized cabling, designed to help improve component access and airflow across the server for better reliability.

1.1.3 Enhanced Virtualization

Featuring embedded hypervisors, large memory capacity with 18 DIMM slots, and four integrated network connections, the Dell PowerEdge R710 delivers better overall system performance and greater virtual machine-per-server capacity. The latest Intel® Xeon® processor technology adapts to your software in real-time, processing more tasks simultaneously. With optional factory-integrated virtualization capabilities, you get tailored solutions that allow you to streamline deployment and simplify virtual infrastructures. Choose your hypervisor from market leaders such as VMware®, Citrix®, and Microsoft®, and enable virtualization with a few mouse clicks.

1.1.4 Energy Efficient

The PowerEdge R710 reduces power consumption while increasing performance capacity with Energy Smart technologies such as right-sized efficient power supply units, improved system-level design efficiency, and policy-driven power and thermal management. Dell's advanced thermal control delivers optimal performance at minimal power consumption without compromising enterprise performance.

1.1.5 Easy to Manage

The PowerEdge R710 lets you devote more focus to running your business. The Dell OpenManage™ suite offers enhanced operations and standards-based commands designed to integrate with existing systems for effective control.

Lifecycle Controller, the optional advanced embedded systems management engine, automates common management tasks and gives you zero-media, low-touch deployment that is efficient, secure and user-friendly. Lifecycle Controller works with the standard iDRAC Express or optional iDRAC Enterprise to help simplify administrator tasks by performing a comprehensive set of provisioning functions such as system deployment, system updates, hardware configuration, and diagnostics from a single intuitive interface called Unified Server Configurator (USC) in a pre-OS environment. This helps eliminate the need to use and maintain multiple pieces of disparate CD/DVD media. With Dell Lifecycle Controller server deployment automation, the R610 can be up and running fast.

Dell Management Console (DMC), powered by Altiris™ from Symantec™, delivers a single view and a common data source into the entire infrastructure. DMC is an easily extensible, modular foundation that can provide basic hardware management or more advanced functions such as asset and security management. It helps reduce or eliminate manual processes so less time and money is spent keeping the lights on and more time can be spent on strategic uses of technology.

1.1.6 Dell Services

Dell Services can help reduce IT complexity, lower costs, and eliminate inefficiencies by making IT and business solutions work harder for you. The Dell Services team takes a holistic view of your needs and designs solutions for your environment and business objectives while leveraging proven delivery methods, local talent, and in-depth domain knowledge for the lowest TCO.

1.2 Comparison

Table 1. Feature Comparison to PowerEdge R610 and R810

Feature	R610	R710	R810
Processor	Intel® Xeon® processor 5500 and 5600 series	Intel® Xeon® processor 5500 and 5600 series	Intel® Xeon® processor 6500 and 7500 series
Form Factor	1U rack	2U rack	2U rack
Front Side Bus	Intel® QuickPath Interconnect (QPI)	Intel® QuickPath Interconnect (QPI)	Intel® QuickPath Interconnect (QPI)
# Sockets	2	2	4
# Cores	2, 4, or 6	2, 4, or 6	4, 6, or 8
L2/L3 Cache	4MB, 8MB, and 12MB	4MB, 8MB, and 12MB	12MB, 18MB, or 24MB (shared)
Chipset	Intel® 5520	Intel® 5520	Intel® 7500
DIMMs	12 DDR3	18 DDR3	32 DDR3
Min/Max RAM	1GB/192GB	1GB/288GB	1GB/512GB

Feature	R610	R710	R810
Drive Bays	6 x 2.5"	4 x 3.5" with optional flex bay, 6 x 3.5" without flex bay, or 8 x 2.5"	6 x 2.5"
Hard Drive Types	Hot-plug SAS and SATA, nearline SAS and SSD	Hot-plug SAS and SATA, nearline SAS and SSD	Hot-plug SAS and SATA, SATA SSD
External Drive Bay(s)	Optional internal SATA slimline optical drives such as DVD-ROM or DVD+RW	Optional flex bay expansion to support half-height tape backup unit	N/A
Embedded Hard Drive Controller	PERC 6/i, SAS 6/iR, PERC H200, PERC H700	PERC 6/i, SAS 6/iR, PERC H200, PERC H700	PERC H200, PERC H700
Optional Storage Controller	Non-RAID: SAS 5/E LSI 2032 (for tape backup unit only) 6Gps SAS HBA RAID: SAS 6/iR PERC 6/i PERC 6/E PERC H200 PERC H700 PERC H800	Non-RAID: SAS 5/E LSI 2032 (for tape backup unit only) 6Gps SAS HBA RAID: SAS 6/iR PERC 6/i PERC 6/E PERC H200 PERC H700 PERC H800	Non-RAID: SAS 5/E LSI 2032 (for tape backup unit only) 6Gps SAS HBA RAID: PERC H200 PERC H700 PERC H800
Availability	Hot-plug hard drives, hot-plug redundant power and cooling, ECC memory, Single Device Data Correction (SDDC), memory demand and patrol scrubbing, high-availability failover cluster	Hot-plug hard drives, hot-plug redundant power and cooling, ECC memory, Single Device Data Correction (SDDC), memory demand and patrol scrubbing, high-availability failover cluster	Hot-plug hard drives, hot-plug redundant power, ECC memory, dual internal SD module
Server Management	iDRAC6 Express, BMC, IPMI 2.0, Dell OpenManage™ Optional: iDRAC6 Enterprise, vFlash	iDRAC6 Express, BMC, IPMI 2.0, Dell OpenManage™ Optional: iDRAC6 Enterprise, vFlash	iDRAC6 Express, BMC, IPMI 2.0, Dell OpenManage™ Optional: iDRAC6 Enterprise, vFlash
I/O Slots	2 PCIe x8 G2	2 PCIe x8 + 2 PCIe x4 G2 or 1 x PCIe x16 + 2 PCIe x4 G2	5 PCIe x8 + 2 PCIe x4

Feature	R610	R710	R810
RAID	SAS 6/iR and PERC H200: RAID 0, 1 PERC 6/i and PERC H700: RAID 0, 1, 5, 6, 10, 50, 60	SAS 6/iR and PERC H200: RAID 0, 1 PERC 6/i and PERC H700: RAID 0, 1, 5, 6, 10, 50, 60	PERC H200: RAID 0, 1 PERC H700/H800: RAID 0, 1, 5, 6, 10, 50, 60
NIC/LOM	Broadcom® BCM5709C 4 x iSCSI TOE Optional: various NICs available	Broadcom® BCM5709C 4 x iSCSI TOE Optional: various NICs available	Broadcom® BCM5709C 4 x iSCSI TOE Optional: various NICs available
USB	2 front, 2 back, 1 internal	2 front, 2 back, 1 internal	2 front, 4 back, 1 internal
Power Supplies	Two redundant hot-plug high-efficiency 502W or two redundant hot-plug high-output 717W	Two redundant hot-plug high-efficiency 570W or two redundant hot-plug high-output 870W	Two redundant hot-plug 1100W
Fans	Six dual-rotor fans (dual processor configuration) or five dual-rotor fans (single processor configuration)	Five hot-plug fans (default processor configuration) or four hot-plug fans (single processor configuration)	Six hot-plug fans

2 Key Technologies

2.1 Overview

Key features of the PowerEdge R710 include dual Intel® Xeon® 5500 and 5600 series quad-core and six-core processors, Intel® 5520 I/O Hub (IOH) with QuickPath Architecture, DDR3 memory, DIMM thermal sensors, PCI Express Generation 2, iDRAC with integrated video controller, dual-port embedded Gigabit Ethernet controllers, Internal SD Module, iDRAC6 Express, and optional iDRAC6 Enterprise.

2.2 Detailed Information

The Intel® Xeon® processor 5500 and 5600 series is designed specifically for servers and workstation applications. The processor features quad-core and six-core processing to maximize performance and performance/watt for data center infrastructures and highly dense deployments. The processor also features the Intel Core™ micro-architecture and Intel 64 architecture for flexibility in 64-bit and 32-bit applications and operating systems. See section 6 for more information.

3 System Overview

For the latest information on supported features for the PowerEdge R710, visit Dell.com.

Table 2. Product Features Summary

Feature	Technical Specification	
Form Factor	2U rack	
Processors	Dual-core, quad-core, or six-core Intel® Xeon® processor 5500 and 5600 series	
Processor Sockets	2	
Front Side Bus or HyperTransport	Intel® QuickPath Interconnect (QPI) (maximum 6.4GT/s)	
Cache	Up to 12MB	
Chipset	Intel® 5520	
Memory ¹	Up to 288GB (18 DIMM slots): 1GB/2GB/4GB/8GB/16GB DDR3 800MHz, 1066MHz, or 1333MHz	
I/O Slots	2 PCIe x8 + 2 PCIe x4 Gen2 or 1 x16 + 2 x4 Gen2	
RAID Controller	Internal Controllers: PERC H200 (6Gb/s) PERC H700 (6Gb/s) (non-volatile battery-backed cache: 512MB, 1G) SAS 6/iR PERC 6/i (battery-backed cache: 256MB)	External Controllers: PERC H800 (6Gb/s) (non-volatile battery-backed cache: 512MB, 1G) PERC 6/E (battery-backed cache: 256MB, 512MB) External HBAs (non-RAID): 6Gb/s SAS HBA SAS 5/E HBA LSI2032 PCIe SCSI HBA
Drive Bays	Up to four 3.5" drives with optional flex bay, up to six 3.5" drives without flex bay, or up to eight 2.5" SAS or SATA drives with flex bay Optional flex bay expansion supports half-height tape backup unit (TBU) Peripheral bay options: Slim optical drive bay with choice of DVD-ROM, Combo CD-RW/DVD-ROM, or DVD+RW	
Maximum Internal Storage	12TB (with 2TB 3.5" nearline SAS or SATA drives)	

Feature	Technical Specification	
Hard Drives ¹	2.5" SAS (10,000 rpm): 146GB, 300GB, 600GB 2.5" SAS (15,000 rpm): 73GB, 146GB 2.5" SATA II (7,200 rpm): 160GB, 250GB, 500GB, 1TB 2.5" nearline SAS (7,200 rpm): 500GB, 1TB 2.5" nearline SAS (7,200 rpm): 1TB 3.5" SATA (7,200 rpm): 250GB, 500GB, 1TB, 2TB 3.5" SATA (5,400 rpm): 2TB 3.5" 6Gps SAS (7,200 rpm): 2TB 3.5" SAS (10,000 rpm): 146GB, 600GB	3.5" SAS (15,000 rpm): 146GB, 300GB, 450GB, 600GB 3.5" nearline SAS (7,200 rpm): 500GB, 1TB, 2TB 2.5" SATA SSD: 50GB, 100GB 2.5" SAS SSD: 149GB Solid State Storage Cards: Fusion-io® 160IDSS—160GB ioDrive PCIe solid state storage card Fusion-io® 640IDSS—640GB ioDrive Duo PCIe solid state storage card
Communications	Four embedded Broadcom® NetXtreme II™ 5709C Gigabit Ethernet NICs with failover and load balancing; TOE (TCPIP Offload Engine) supported on Microsoft® Windows Server® 2003 SP1 or higher with Scalable Networking Pack; Optional 1GBe and 10GBe add-in NICs: Broadcom® NetXtreme II™ 57711 Dual Port Direct Attach 10Gb Ethernet PCI-Express Network Interface Card with TOE and iSCSI Offload	Intel® Gigabit ET Dual Port Server Adapter and Intel® Gigabit ET Quad Port Server Adapter Dual Port 10GB Enhanced Intel Ethernet Server Adapter X520-DA2 (FcoE Ready for Future Enablement) Optional add-in NICs: Brocade® CNA (1020) Dual Port Server Adapter Optional add in HBAs: Brocade® 8 GB HBAs Emulex® OCE10102-IX-DCNA iSCSI HBA stand-up adapter
Power Supply	Energy Smart: redundant hot-plug high-efficient 570W or High Output: redundant hot-plug 870W	
Availability	DDR3 memory, hot-plug hard drives, optional hot-plug redundant power supplies, dual embedded NICs with failover and load balancing support, optional PERC6/i integrated daughtercard controller with battery-backed cache (or other controllers with battery-backed cache or non-volatile cache), hot-plug redundant cooling, toolless chassis, fibre and SAS cluster support, validated for Dell/EMC SAN	
Video	Matrox® G200 with 8MB of cache	
Remote Management	iDRAC6 Enterprise (optional)	
Systems Management	Dell™ OpenManage™ Microsoft® System Center Essential (SCE) 2010 v2	

Feature	Technical Specification
<p>Rack Support</p>	<p>ReadyRails™ sliding rails with optional cable management arm for 4-post racks (optional adapter brackets required for threaded hole racks)</p> <p>ReadyRails™ static rails for 2-post and 4-post racks</p>
<p>Operating Systems</p>	<p>Microsoft® Windows® Small Business Server 2008</p> <p>Microsoft® Windows® Essential Business Server 2008</p> <p>Microsoft® Windows Server® 2008 SP2, x86/x64 (x64 includes Hyper-V™)</p> <p>Microsoft® Windows Server® 2008 R2, x64 (includes Hyper-V™ v2)</p> <p>Windows® HPC Server 2008 R2</p> <p>Novell® SUSE® Linux® Enterprise Server</p> <p>Red Hat® Enterprise Linux®</p> <p>Sun® Solaris™</p> <p>Optional Embedded Hypervisors:</p> <p>Citrix® XenServer™</p> <p>Microsoft® Hyper-V™ through Microsoft® Windows Server® 2008</p> <p>VMware® vSphere™ 4.1 (including VMware ESX® 4.1 or VMware ESXi™ 4.1)</p> <p>For more information on the specific versions and additions, visit www.dell.com/OSsupport.</p>
<p>Featured Database Applications</p>	<p>Microsoft® SQL Server® solutions (see Dell.com/SQL)</p> <p>Oracle® database solutions (see Dell.com/Oracle)</p>
<p>¹GB means 1 billion bytes and TB equals 1 trillion bytes; actual capacity varies with preloaded material and operating environment and will be less.</p>	

4 Mechanical

4.1 Chassis Description

The PowerEdge R710 is a 2U rack-mount design that supports the following features:

- New LCD control panel, bezel, and hard-drive carriers
- Toolless rack latches,
- Pull-out tray for customer labels
- Embedded NIC 1 and iDRAC MAC addresses
- Support for persistent storage:
 - Internal USB and SD card slot
 - One external vFlash media slot (on optional iDRAC6 Enterprise card)
- Updated power supplies and removal process

4.2 Dimensions and Weight

Figure 1 details the dimensions and weight for the PowerEdge R710.

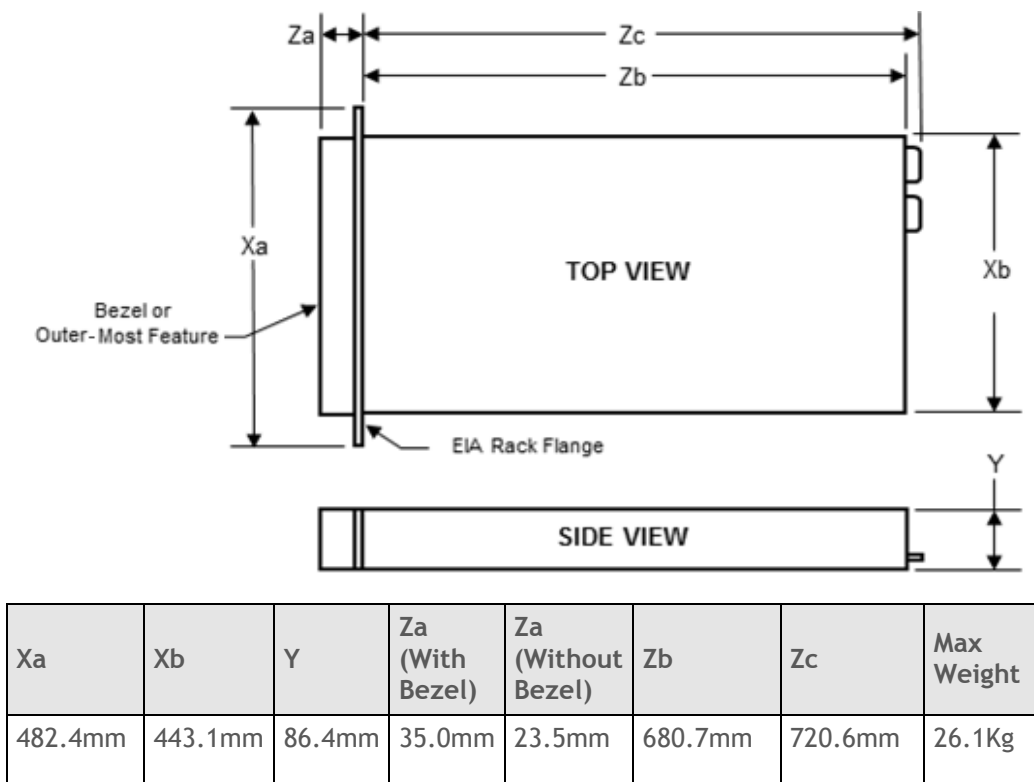

Figure 1. Chassis Dimensions

4.3 Front Panel View and Features

The PowerEdge R710 is available in two chassis configurations: 3.5” hard drive chassis (see Figure 2) and 2.5” hard drive chassis (see Figure 3).



Figure 2. Front View (3.5” Hard Drive Chassis)



Figure 3. Front View (2.5” Hard Drive Chassis)



Figure 4. Front View (With Optional Bezel)

See the Front-Panel Features and Indicators section in the About Your System chapter of the *PowerEdge R710 Hardware Owner’s Manual* on Support.Dell.com for more information.

4.4 Back Panel View and Features

Figure 5 shows the back view of the PowerEdge R710 server.







Figure 5. Back View

See the Back-Panel Features and Indicators section in the About Your System chapter of the *PowerEdge R710 Hardware Owner’s Manual* on Support.Dell.com for more information.

4.5 Power Supply Indicators

The PowerEdge R710 redundant power supplies have one status bi-color LED: green for AC power present and amber for a fault as detailed in Table 3.

Table 3. Power Supply Status

LED	Power Supply Status
	AC Power is not present
	AC Power is present
	Fault of any kind is detected
	DC Power is applied to the system
	Redundant power supply mismatch (when hot-plugged/swapped)

See the Power Indicator Codes section in the About Your System chapter of the *PowerEdge R710 Hardware Owner's Manual* on Support.Dell.com for more information.

4.6 NIC Indicators

See the NIC Indicator Codes section in the About Your System chapter of the *PowerEdge R710 Hardware Owner's Manual* on Support.Dell.com for more information.

4.7 Internal Chassis Views

Figure 6 shows the internal view of the PowerEdge R710 server.



Figure 6. Internal Chassis View

4.8 Rails and Cable Management

4.8.1 ReadyRails Sliding Rails

ReadyRails™ Sliding Rails for 4-post racks support the following:

- Toolless installation in 19" EIA-310-E compliant square or unthreaded round hole 4-post racks including all generations of Dell racks
- Toolled installation in 19" EIA-310-E compliant threaded hole 4-post racks (requires the 2U Threaded Rack Adapter Brackets Kit)
- Full extension of the system out of the rack to allow serviceability of key internal components
- Optional cable management arm (CMA)

Dell

4.8.2 ReadyRails Static Rails

ReadyRails™ Static Rails for 4-post and 2-post racks support the following:

- Toolless installation in 19" EIA-310-E compliant square or unthreaded round hole 4-post racks including all generations of Dell racks
- Tooled installation in 19" EIA-310-E compliant threaded hole 4-post and 2-post racks

See section 14 for more details.

4.9 Fans

Five hot-swappable fans are mounted in a fan gantry that is located in the chassis between the hard drive bay and the processors. See Figure 7. Each fan has a blind mate 2x2 connector that plugs directly into the planar. There is an additional fan integrated in each power supply to cool the power supply subsystem and also provide additional cooling for the whole system. Single processor configurations have four fans populated.

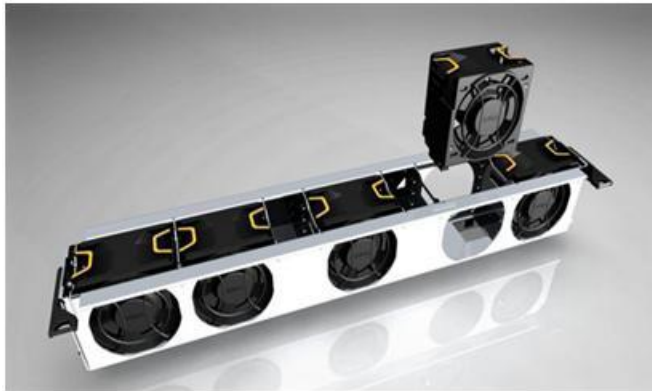

Figure 7. Fan Gantry

The Embedded Server Management logic in the system monitors the speed of the fans. A fan failure or over-temperature in the system results in a notification by iDRAC6. All system fans are pulse-width modulated fans. Redundant cooling is supported.

4.10 LCD Control Panel

The LCD control panel is located on the front of the system chassis to provide user access to switches, display, and I/O interfaces. See Figure 8. The control panel includes the following features:

- ACPI-compliant power button with an integrated green power LED (controlled by iDRAC6)
- 128x20 pixel LCD with controls:
 - Two navigation buttons
 - Select button
 - System ID button
- Non-maskable Interrupt (NMI) button (recessed)
- Ambient temperature sensor



Figure 8. Control Panel

The LCD panel is a graphics display controlled by the iDRAC6. Both iDRAC6 and BIOS can send error codes and messages to the display.

The system's LCD panel provides system information and status messages to signify when the system is operating correctly or when the system needs attention.

BIOS has the ability to enter a secure mode through Setup, which locks the Power and NMI buttons. When in this mode, the power button can still be used to turn on the server even when the power button is disabled in System Setup.

For more information on the LCD panel, see the LCD Panel Features section in the About Your System chapter in the *PowerEdge R710 Hardware Owner's Manual* on Support.Dell.com.

4.11 Security

For additional information regarding the following security features, see the *PowerEdge R710 Hardware Owner's Manual* on Support.Dell.com.

4.11.1 Cover Latch

The PowerEdge R710 comes with a coin lock entry latch on the top cover of the unit and provides security for the entire system. The lock provides for toolless access to the chassis.

4.11.2 Bezel

A metal bezel is mounted to the chassis. A lock on the bezel is used to protect unauthorized access to system peripherals and the LCD control panel. System status on the LCD panel is viewable even when the bezel is installed.

4.11.3 Hard Drive

The optional front bezel of the system contains a lock which secures the system hard drives. Some hard drives can still be unplugged from the backplane with the bezel present, but they cannot be removed from the chassis.

Dell

4.11.4 TPM

The TPM is used to generate and store keys, protect and authenticate passwords, and create and store digital certificates. The TPM can also be used to store Microsoft® BitLocker™ keys for hard drive encryption features in Microsoft® Windows Server® 2008. TPM is enabled through a BIOS option and uses HMAC-SHA1-160 for binding.

4.11.5 Power Off Security

The control panel is designed so the power switch cannot be accidentally activated. The lock on the bezel secures the switch behind the bezel. In addition, there is a setting in the CMOS setup that disables the power button function.

4.11.6 Intrusion Alert

A switch mounted on Riser 2 is used to detect chassis intrusion. When the cover is opened, the switch circuit closes and indicates intrusion to the iDRAC6. When enabled, the software can provide notification that the cover has been opened.

4.11.7 Secure Mode

BIOS has the ability to enter a secure boot mode through Setup. This mode includes the option to lock out the power and NMI switches on the control panel or set up a system password.

4.12 USB Key

The port on the control panel is for an optional USB key and is located inside the chassis. Some possible applications of the USB key are listed as follows:

- User custom boot and pre-boot OS for ease of deployment or diskless environments
- USB license keys for software applications like eToken™ or Sentinel Hardware Keys
- Storage of custom logs or scratch pads for portable user defined information (not hot-swappable)

4.13 Battery

A replaceable coin cell CR2032 3V battery is mounted on the planar to provide backup power for the Real-Time Clock and CMOS RAM on the ICH9 chip.

4.14 Field Replaceable Units (FRU)

The planar contains a serial EEPROM to contain FRU information including Dell part number, part revision level, and serial number. The backplane storage enclosure processor (SEP) and the power supply microcontrollers are also used to store FRU data.

4.15 User Accessible Jumpers, Sockets, and Connectors

See the Jumpers and Connectors chapter in the *PowerEdge R710 Hardware Owner's Manual* on Support.Dell.com.

5 Power, Thermal, Acoustic

5.1 Power Efficiency

One of the main features of the 11G family of servers is enhanced power efficiency. The R710 achieves higher power efficiency by implementing the following features:

- User-selectable power cap (subsystems throttle to maintain the specified power cap)
- Improved power budgeting
- Power-supply and voltage-regulator (VR) efficiency improvements
- Use of switching regulators instead of linear regulators
- Closed-loop thermal throttling
- Increased rear venting and 3D venting
- Pulse-width modulated (PWM) fans with an increased number of fan zones and configuration-dependent fan speeds
- Use of DDR3 memory (lower voltage compared to DDR2, UDIMM)
- Processor VR dynamic phase shedding
- Memory VR static phase shedding
- Random time interval for system start
- Ability for an entire rack to power on without exceeding the available power
- BIOS Power/Performance options page
- Active Power Controller (BIOS-based CPU P-state manager)
- Ability to power down or throttle memory
- Ability to disable a processor core
- Ability to turn off embedded NICs or PCIe lanes when not being used
- Option to run PCIe at Gen1 speeds instead of Gen2

5.2 Main Power Supply

The base redundant R710 system consists of two hot-plug 570W Energy Smart (energy efficient) power supplies in a 1+1 configuration. An 870W high-output power supply is also available.

The power supplies connect directly to the planar. There is a power cable to connect between the planar and the backplane. The R710 power supplies have embedded cooling fans.

Field replaceable unit (FRU) data is stored in the memory of the power supply microcontroller. Additionally, the power supply firmware can be updated by the iDRAC over the PMBus.

Power is soft-switched, allowing power cycling using a switch on the front of the system enclosure or by software control (through server management functions).

In a single power supply configuration, the power supply is installed in PS1 location and a power supply blank (metal cover) is installed in PS2 location for proper system cooling.



Figure 9. Power Supplies

5.3 Power Supply Specifications

Table 4. Power Supply Specifications

Feature	Specification
Wattage	870 Watt (high-output) 570 Watt (Energy Smart)
Voltage	90-264 VAC, auto-ranging, 47-63 Hz
Maximum inrush current	Under typical line conditions and over the entire system ambient operating range, the inrush current may reach 55A per power supply for 10ms or less.

5.4 Heat Dissipation

High Output (870W) power supply: 2968.6 BTU/hr maximum

Energy Smart (570W) power supply: 1944.9 BTU/hr maximum

5.5 Environmental Specifications

Table 5. Environmental Specifications

Temperature	
Operating	10° to 35°C (50° to 95°F) with a maximum temperature gradation of 10°C per hour Note: For altitudes above 2950 feet, the maximum operating temperature is derated 1°F/550 ft.
Storage	-40° to 65°C (-40° to 149°F) with a maximum temperature gradation of 20°C per hour
Relative Humidity	
Operating	20% to 80% (noncondensing) with a maximum humidity gradation of 10% per hour

Storage	5% to 95% (noncondensing) with a maximum humidity gradation of 10% per hour
Maximum Vibration	
Operating	0.26 Grms at 5-350Hz in operational orientations
Storage	1.54 Grms at 10-250Hz in all orientations
Maximum Shock	
Operating	Half sine shock in all operational orientations of 31G +/- 5% with a pulse duration of 2.6ms +/-10%
Storage	Half sine shock on all six sides of 71G +/- 5% with a pulse duration of 2 ms +/-10% Square wave shock on all six sides of 27G with velocity change @ 235 in/sec or greater
Altitude	
Operating	-16 to 3048m (-50 to 10,000ft) Note: For altitudes above 2950 feet, the maximum operating temperature is derated 1°F/550 ft.
Storage	-16 to 10,600m (-50 to 35,000ft)

5.6 Power Consumption Testing

Table 6. Power Consumption Testing

Feature	Energy Smart Power Supply	High-Output Power Supply
Dimensions	L-206.4 mm ¹ x W-67.5 mm x H-76.5 mm	
Status Indicators	1 x bi-color Light Emitting Diode	
Integrated Fans	1 x 60 mm	
Fixed Input Plug	IEC-C14 	
AC Cord Rating	15 Amps @ 120 VAC, 10 Amps @ 240 VAC	
Input Voltage	90-264 VAC	
Auto-ranging	Yes	
Line Frequency	47 - 63 Hertz	
Maximum Inrush Current	55 Amps per supply for 10 ms or less	
Hot-Swap Capability	Yes	
Output Power	570 Watts	870 Watts
Maximum Heat Dissipation	1944.9 BTU per hour	2968.6 BTU per hour
Efficiency (20% - 100% Load)	86.9-90.5% @ 115 VAC 88-92% @ 230 VAC	85-88% @ 115 VAC 87-90% @ 230 VAC

¹ Does not include the power supply handle or ejection tab

5.7 Maximum Input Amps

Maximum input current (High Output—870W):

- 12 A @ 90 VAC
- 6 A @ 180 VAC

Maximum input current (Energy Smart—570W):

- 7.8 A @ 90 VAC
- 3.9 A @ 180 VAC

5.8 Energy Smart Enablement

The 11G family of PowerEdge servers implements aspects of Dell’s Energy Smart strategy. This strategy offers the following:

- Energy Smart components on a portfolio level, such as high-capacity and Energy Smart power supplies
- Systems with either a lowest power footprint configuration or a best performance per watt configuration
- Energy Smart components (such as DIMMs or hard drives) selected without cherry picking or screening individual manufacturer’s components based on energy consumption

5.9 Energy Star Compliance

ENERGY STAR® qualified configurations can be accessed from the [ENERGY STAR Compliance results](#) landing page on Dell.com.

5.10 Acoustics

The acoustical design of the PowerEdge R710 reflects adherence to Dell’s high sound quality standards. Sound quality is different from sound power level and sound pressure level in that it describes how humans respond to annoyances in sound, like whistles, hums, etc. One of the sound quality metrics in the Dell specification is prominence ratio of a tone as shown in Table 7.

Table 7. Acoustical Performance

Typical Configuration @ 23 ± 2 °C				Operating Mode	L _{WA} -UL (Bels)	L _{pA} (dBA)	Prominent Tones
CPUs	HDDs	Power Supplies	Optical Drive				
2	4	2	1	Idle	5.5	39	None
				Stressed	5.9	42	None

The acoustical specification for the R710 is Category II-D.

Definitions

Idle: Reference ISO7779 (1999) definition 3.1.7; system is running in its OS but no other specific activity.

Stressed Processor: An operating mode per ISO7779 (1999) definition 3.1.6. The software SPECPower_ssj2008 is utilized to stress the processors. SPECPower is set to 50% loading.

L_{WA} - UL: The upper limit sound power level (L_{WA}) calculated per section 4.4.2 of ISO 9296 (1988) and measured in accordance to ISO 7779 (1999).

Dell

LpA: Average bystander A-Weighted sound pressure level. The system is placed in a rack with its bottom at 25 cm from the floor. The acoustic transducers are at the four bystander positions, ref ISO7779 (1999) Section 8.6.2.

Prominent tone: Criteria of D.5 and D.8 of ECMA-74 9th ed. (2005) are followed to determine if discrete tones are prominent. The system is placed in a rack with its bottom at 75 cm from the floor. The acoustic transducer is at front bystander position, ref ISO7779 (1999) Section 8.6.2.

6 Processors

6.1 Overview

The Intel® Xeon® processor 5500 and 5600 series 2S is the microprocessor designed specifically for servers and workstation applications. The Intel Xeon processor 5500 series features quad-core processing to maximize performance and performance/watt for datacenter infrastructures and highly dense deployments. The Intel 5600 series features six-core processing, offering enhanced system-level performance, virtualization, and energy efficiency. The Intel Xeon processor 5500 and 5600 series also feature Intel's Core™ micro-architecture and Intel 64 architecture for flexibility in 64-bit and 32-bit applications and operating systems.

The Intel Xeon processor 5500 and 5600 series uses a 1366-contact Flip-Chip Land Grid Array (FC-LGA) package that plugs into a surface mount socket. The PowerEdge R710 provides support for up to two processors.

Table 8. Intel Xeon 5500 and 5600 Processor Series Features

Feature	5500 Series	5600 Series
# Cores	4	6
Last Level Cache	8MB shared	12MB shared
Multi-processor support	1-2 Processors	1-2 Processors
Front Side Bus (FSB) (MHz)/ Link Frequency (GT/s)	Up to 6.4 GT/s	Up to 6.4 GT/s
Max Thermal Design Power (TDP)	130W (workstation) 95W (server)	130W (workstation) 95W (server)
Max Frequency	>3GHz	>3GHz
Memory Controller	Integrated 3-channel DDR3	Integrated 3-channel DDR3
Process Technology	45nm	32nm
Intel® Trusted Execution Technology	No	Yes
Intel® Advanced Encryption Security- New Instructions	No	Yes
Intel® Virtualization Technology	Yes	Yes
Intel® 64	Yes	Yes

Feature	5500 Series	5600 Series
Intel® Hyper-Threading Technology	Yes	Yes
Socket	LGA1366	LGA1366

6.2 Features

Key features of the Intel Xeon processor 5500 and 5600 include:

- Two, four, or six cores per processor
- Two point-to-point QuickPath Interconnect links at 6.4 GT/s
- 1366-pin FC-LGA package
- 32 nm and 45 nm process technology
- No termination required for non-populated processors (must populate CPU socket 1 first)
- Integrated QuickPath DDR3 memory controller 64-byte cache line size RISC/CISC hybrid architecture
- Compatible with existing x86 code base
- MMX™ support—Execute Disable Bit Intel Wide Dynamic Execution
- Ability to executes up to four instructions per clock cycle
- Simultaneous Multi-Threading (SMT) capability
- Support for CPU Turbo Mode (on certain processors)—increases processor frequency if operating below thermal, power, and current limits for streaming SIMD (Single Instruction, Multiple Data) Extensions 2, 3, and 4
- Intel 64 Technology Intel VT-x and VT-d Technology for virtualization support Enhanced Intel SpeedStep® Technology
- Demand-based switching for active processor power management as well as support for ACPI P-States, C-States and T-States
- Support for DDR3L, 1.35v DIMMs for even lower system power (5600 series)
- Support for memory sparing (5600 series)
- AES-NI (hardware encryption assist) for more efficient encryption for uses such as online transactions SSL (5600 series)
- Intel TXT (Trusted Execution Technology) provides hardware assisted protection against emerging software attacks (5600 series)

6.3 Supported Processors

For the latest information on supported processors for the PowerEdge R710, visit Dell.com.

Table 9. Supported Processors

Model	Speed	Power	Cache	Cores	QPI Speed
X5680	3.33GHz	130W	12M	6	6.4GT/s
X5670	2.93GHz	95W	12M	6	6.4GT/s
X5660	2.80GHz	95W	12M	6	6.4GT/s
X5650	2.66GHz	95W	12M	6	6.4GT/s
L5640	2.26GHz	60W	12M	6	5.86GT/s
X5677	3.46GHz	130W	12M	4	6.4GT/s

Model	Speed	Power	Cache	Cores	QPI Speed
X5667	3.06GHz	95W	12M	4	6.4GT/s
E5640	2.66GHz	80W	12M	4	5.86GT/s
E5630	2.53GHz	80W	12M	4	5.86GT/s
E5620	2.40GHz	80W	12M	4	5.86GT/s
L5630	2.13GHz	40W	12M	4	5.86GT/s
L5609	1.86GHz	40W	12M	4	4.8GT/s
X5560	2.80GHz	95W	8M	4	6.4GT/s
E5530	2.40GHz	80W	8M	4	5.86GT/s
L5520	2.26GHz	60W	8M	4	5.86GT/s
E5507	2.26GHz	80W	4M	4	4.8GT/s
E5506	2.13GHz	80W	4M	4	4.8GT/s
E5503	2.00GHz	80W	4M	4	4.8GT/s

6.4 Processor Configurations

6.4.1 Single Processor Configuration

The PowerEdge R710 is designed so that a single processor placed in the CPU1 socket functions normally. The system will halt during power-on self-test (POST) if a single processor is placed in the CPU2 socket. If using a single processor, the R710 requires a heatsink blank in the CPU2 socket for thermal reasons.

6.4.2 Processor Power Voltage Regulation Modules (EVRD 11.1)

Voltage regulation to the Intel Xeon processor 5500 and 5600 series 2S is provided by EVRD (Enterprise Voltage Regulator-Down). EVRDs are embedded on the planar. Processor core voltage is not shared between processors. EVRDs support static phase shedding and power management through the PMBus.

6.5 Processor Installation

Refer to the Processors section in the Installing System Components chapter of the *Dell PowerEdge R710 Systems Hardware Owner's Manual* on Support.dell.com for processor installation and removal instructions.

7 Memory

7.1 Overview

The PowerEdge R710 uses DDR3 memory, providing a high-performance, high-speed memory interface capable of low latency response and high throughput. The R710 supports Registered ECC DDR3 DIMMs (RDIMM) or Unbuffered ECC DDR3 DIMMs (UDIMM).

The system contains 18 memory sockets split into two sets of nine sockets, one set for each processor. Each nine-socket set is organized into three channels of three memory sockets per channel.

Key features of the R710 memory system include the following:

- Registered (RDIMM) and Unbuffered (UDIMM) ECC DDR3 technology
- Up to 288 GB of RDIMM memory (eighteen 16 GB dual rank RDIMMs)
- Up to 24 GB of UDIMM memory (twelve 2 GB UDIMMs)
- Support for 1066/1333 MHz single- and dual-rank DIMMs
- Support for 1066 MHz quad-rank DIMMs
- Support for 1.35V low voltage (LV) DIMMs with 5600 series processors
- 64 data and eight ECC bits per channel
- Support for single DIMM configuration (DIMM in socket A1 only)
- Support for ODT (On Die Termination) clock gating (CKE) to conserve power when DIMMs are not accessed (DIMMs enter a low power self-refresh mode)
- I2C access to SPD EEPROM for access to RDIMM thermal sensors
- Single Bit Error Correction
- SDDC (Single Device Data Correction, x4 or x8 devices)
- Support for Closed Loop
- Thermal Management on RDIMMs and UDIMMs
- Multi Bit Error Detection Support for Memory Optimized Mode
- Support for Advanced ECC mode
- Support for Memory Mirroring
- Support for Memory Sparring with 5600 series processors

7.2 DIMMs Supported

The DDR3 memory interface consists of three channels with up to three RDIMMs or two UDIMMs per channel for single or dual rank and up to two RDIMMs per channel for quad rank. The interface uses 2 GB, 4 GB, 8 GB, or 16GB RDIMMs. Also supported are 1 GB or 2 GB UDIMMs.

7.2.1 Memory Modes

The memory mode is dependent on how the memory is populated in the system, according to the following configurations:

- Three channels per processor populated identically
- Dual-processor configuration with the memory configurations for each processor being identical
 - Typically, the system will be set to run in Memory Optimized (Independent Channel) mode in this configuration.
 - This mode offers the most DIMM population flexibility and system memory capacity, but offers the least number of RAS (reliability, availability, service) features.
 - Memory modules are installed in numeric order for the sockets beginning with A1 or B1.

Dell

- The first two channels per processor populated identically with the third channel unused
 - Typically, two channels operate in Advanced ECC (Lockstep) mode with each other by having the cache line split across both channels.
 - This mode provides improved RAS features (SDDC support for x8-based memory).
 - For memory mirroring, two channels operate as mirrors of each other (writes go to both channels and reads alternate between the two channels).
 - For Memory Mirroring or Advanced ECC Mode, the three sockets farthest from the processor are unused and memory modules are installed beginning with socket A2 or B2, proceeding in the following order: A2, A3, A5, and A6.
- One channel per processor populated
 - This is a simple Memory Optimized mode.
 - Mirroring is not supported.

7.2.2 DIMM Population Rules

The following DIMM population rules apply:

- If DIMMs of different speeds are mixed, all channels will operate at the fastest common frequency. RDIMMs and UDIMMs cannot be mixed.
- If memory mirroring is enabled, identical DIMMs must be installed in the same slots across both channels.
- The third channel of each processor is unavailable for memory mirroring.
- The R710 memory system supports up to 18 DIMMs. DIMMs must be installed in each channel starting with the DIMM farthest from the processor. Population order is identified by the silkscreen designator and the System Information Label (SIL) located on the chassis cover.

DIMM slot population for each memory mode is listed as follows:

- Memory Optimized: [1, 2, 3], [4, 5, 6], [7, 8, 9]
- Advanced ECC or Mirrored: [2, 3], [5, 6], [8, 9]
- Quad Rank or UDIMM: [1,2,3], [4,5,6]

See the figure below for the layout of the R710 memory channels.

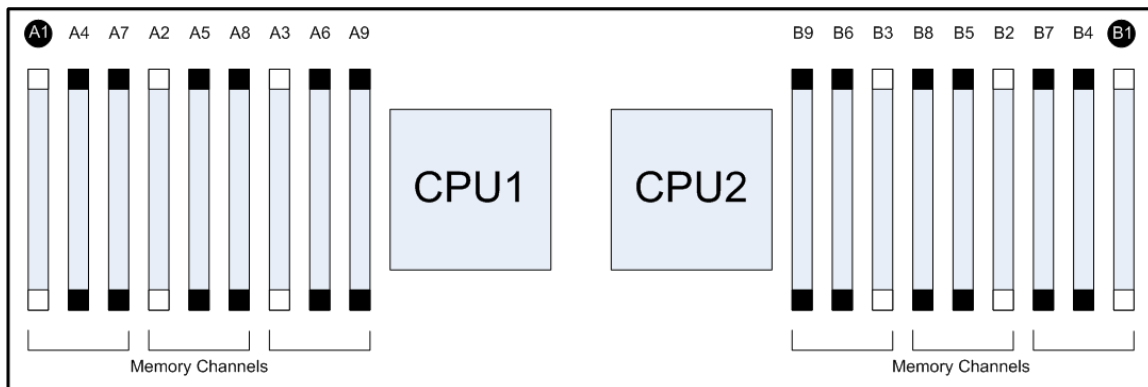

Figure 10. Memory Channels

7.3 Speed

The memory frequency is determined by a variety of inputs:

- Speed of the DIMMs
- Speed supported by the processor
- Configuration of the DIMMs

The memory speed of each channel depends on the memory configuration:

- For single- or dual-rank memory modules:
 - One memory module per channel supports up to 1333 MHz
 - Two memory modules per channel support up to 1066 MHz
 - Three memory modules per channel are limited to 800 MHz, regardless of the memory module speed
- For quad-rank memory modules:
 - One memory module per channel supports up to 1066 MHz
 - Two memory modules per channel are limited to 800 MHz, regardless of memory module speed

If memory modules with different speeds are installed, they will operate at the speed of the slowest installed memory module(s).

7.4 DIMM Slots

The PowerEdge R710 has 18 DIMM slots for memory. It does not have any riser cards for DIMM population.

The first DIMM slot in each channel is color-coded with white ejection tabs for ease of installation. The DIMM sockets are placed 450 mils (11.43 mm) apart, center-to-center to provide enough space for sufficient airflow to cool stacked DIMMs.

7.5 Low Voltage DIMMs

With the introduction of the Intel® Xeon® processor 5600 series, low voltage (LV) DIMMs have been added in selected memory configurations for the PowerEdge R710. Only this processor series supports operating DIMMs at the lower voltage (1.35V, also referred to as DDR3L). The Intel Xeon 5500 processor series does not support low voltage operation. However, due to the backwards-compatible nature of low voltage DIMMs, they can be operated at 1.5V. Therefore, DDR3L DIMMs can be used in systems with either processor series, and the platform will automatically choose the appropriate operating voltage based on the processor populated. DDR3L DIMMs will be qualified and available for use with Intel Xeon 5500 processor series mid-year 2011. Contact your Dell Sales Representative or visit Dell.com for more information.

LV DIMMs operate at 1.35V, creating power savings vs. standard memory which operates at 1.5V. In order to achieve power savings, all DIMMs in the system must be of the LV type. If the system detects a mixture of standard and LV DIMMs, the BIOS will operate all memory at 1.5V. When operating at the lower voltage, additional frequency and population restrictions can take effect. For example, 3 DIMMs per channel operation is not supported at low voltage.

The DDR3L standard is completely backwards-compatible at standard voltage. DDR3L DIMMs can operate at 1.5V without any limitations beyond standard voltage DDR3 DIMMs. As part of the addition of LV DIMMs, the platform has certain default behaviors. Whenever possible, if there is no performance degradation, the platform will default to 1.35V operation when using DDR3L DIMMs. In certain cases, where a configuration is populated that cannot support 1.35V or a performance degradation would result, the platform defaults to 1.5V operation. There are also options to override default voltage within allowed limits.

7.6 Mirroring

The R710 system supports memory mirroring if identical memory modules are installed in the two channels closest to the processor (memory not installed in the farthest channel). Mirroring must be enabled in the System Setup program. In a mirrored configuration, the total available system memory is one-half of the total installed physical memory.

7.7 Sparing

Systems with the Intel Xeon processor 5600 series support memory sparing. Sparing requires identical memory installed in all three channels. One of the three channels is considered the Spare Channel, and two-thirds of the total installed memory is usable and is the amount reported during POST and in BIOS setup.

7.8 Memory Scrubbing

The PowerEdge R710 memory interface supports memory demand and patrol scrubbing, single-bit correction and multi-bit error detection. Correction of a x4 or x8 device failure is also possible with SDDC in the Advanced ECC mode. Additionally, correction of a x4 device failure is possible in the Memory Optimized mode.

7.9 Advanced ECC (Lockstep) Mode

In Advanced ECC (Lockstep) mode, the two channels closest to the processor are combined to form one 128-bit channel. This mode supports Single Device Data Correction (SDDC) for both x4- and x8-based memory modules. Memory modules must be identical in size, speed and technology in corresponding slots.

7.10 Optimizer (Independent Channel) Mode

In Optimizer (Independent Channel) mode, all three channels are populated with identical memory modules. This mode permits a larger total memory capacity but does not support SDDC with x8-based memory modules.

A minimal single-channel configuration of 1 GB memory modules per processor is also supported in this mode.

7.11 Supported Configurations

See the System Memory section in the Installing System Components chapter in the *Dell PowerEdge R710 Systems Hardware Owner's Manual* on Support.dell.com.

8 Chipset

8.1 Overview

The PowerEdge R710 planar incorporates the Intel® Xeon® 5500 processor series chipset for I/O and processor interfacing. This chipset is designed to support the Intel Xeon 5500 and 5600 processor series family, QuickPath Interconnect, DDR3 memory technology, and PCI Express Generation 2. The chipset consists of the Intel 5500 chipset I/O Hub (IOH) and ICH9.

8.1.1 Intel I/O Hub (IOH)

The planar uses the Intel 5500 chipset IOH to provide a link between the Intel Xeon processor series 5500 and 5600 processor(s) and the I/O components. The main components of the IOH consist of two full-width QuickPath Interconnect links (one to each processor), 36 lanes of PCI Express Gen2, a x4 Direct Media Interface (DMI), and an integrated IOxAPIC.

8.1.2 IOH QuickPath Interconnect (QPI)

The QuickPath Architecture consists of serial point-to-point interconnects for the processors and the IOH. The R710 has a total of three QuickPath Interconnect (QPI) links—one link connecting the processors, and multiple links connecting both processors with the IOH. Each link consists of 20 lanes (full-width) in each direction with a link speed of 6.4 GT/s. An additional lane is reserved for a forwarded clock. Data is sent over the QPI links as packets.

The QuickPath Architecture implemented in the IOH and processors features four layers:

- **Physical layer**—This layer consists of the actual connection between components. It supports Polarity Inversion and Lane Reversal for optimizing component placement and routing.
- **Link layer**—This layer is responsible for flow control and the reliable transmission of data.
- **Routing layer**—This layer is responsible for the routing of QPI data packets.
- **Protocol layer**—This layer is responsible for high-level protocol communications, including the implementation of a MESIF (Modify, Exclusive, Shared, Invalid, Forward) cache coherence protocol.

8.1.3 IOH PCI Express

PCI Express is a serial point-to-point interconnect for I/O devices. PCIe Generation 2 doubles the signaling bit rate of Generation 1 from 2.5 Gb/s to 5 Gb/s. Each of the PCIe Gen2 ports are backwards-compatible with Gen1 transfer rates.

The IOH has 36 PCI Express lanes. The lanes are partitioned as two x2 PCI Express Gen2 ports and eight x4 PCI Express Gen2 ports. The x2 ports can be combined as a x4 link; however, this x4 link cannot be combined with any of the other x4 ports. Two neighboring x4 ports can be combined as a x8 link, and both resulting x8 links can combine to form a x16 link.

8.1.4 Intel I/O Controller Hub 9 (ICH9)

ICH9 is a highly-integrated I/O controller, supporting the following functions:

- Six x1 PCI Express Gen1 ports, with the capability of combining ports 1-4 as a x4 link
- PCI Bus 32-bit Interface Rev 2.3 running at 33 MHz
- Serial ATA (SATA) ports with transfer rates up to 300 MB/s (R710 supports two SATA ports for optical devices or tape backup)
- Six UHCI and two EHCI (high-speed 2.0) USB host controllers, with up to 12 USB ports (R710 uses five of these ports for internal and external use)

Dell

- Four external USB ports and one internal USB port
- Power management interface (ACPI 3.0b compliant)
- Platform Environmental Control Interface (PECI)
- I/O interrupt controller
- SMBus 2.0 controller
- Low Pin Count (LPC) interface to Super I/O, Trusted Platform Module (TPM), and SPI-VU
- Serial Peripheral Interface (SPI) support for up to two devices (R710 BIOS is connected to the ICH9 using SPI)

9 BIOS

9.1 Overview

The R710 BIOS is based on the Dell BIOS core, supporting the following features:

- Intel® Xeon® 5500 and 5600 processor series 2S support
- Simultaneous Multi-Threading (SMT) support
- Processor Turbo Mode support
- PCI 2.3 compliant
- Plug and Play 1.0a compliant
- MP (Multiprocessor) 1.4 compliant
- Ability to boot from hard drive, optical drive, iSCSI drive, USB key, and SD card
- ACPI support
- Direct Media Interface (DMI) support
- PXE and WOL support for on-board NICs
- Memory mirroring support
- SETUP access through <F2> key at end of POST
- USB 2.0 (USB boot code is 1.1 compliant)
- F1/F2 error logging in CMOS
- Virtual KVM, CD, and floppy support
- UEFI 2.1 support
- Power management support, including DBS, Power Inventory, and multiple power profiles
- Intel TXT (5600 series)
- Intel AESNI (5600 series)

The R710 BIOS does not support the following:

- BIOS language localization
- BIOS recovery after bad flash (can be recovered from iDRAC6 Express)

9.2 Supported ACPI States

The Advanced Configuration and Power Interface is a standard interface for enabling the operating system to direct configuration and power management.

The Intel Xeon processor 5500 and 5600 series supports the following C-States: C0, C1, C1E, C3, and C6. The R710 supports all of the available C-States.

9.3 I²C (Inter-Integrated Circuit)

I²C is a simple bi-directional two-wire bus for efficient inter-integrated circuit control. All I²C-bus compatible devices incorporate an on-chip interface which allows them to communicate directly with each other via the I²C bus. This design concept solves the many interfacing problems encountered when designing digital control circuits. These I²C devices perform communication functions between intelligent control devices (e.g., microcontrollers), general-purpose circuits (e.g., LCD drivers, remote I/O ports, memories) and application-oriented circuits.

The PowerEdge R710 BIOS accesses the I²C through the ICH9 (Intel I/O Controller Hub 9). There are two multiplexers (MUX) on the ICH9 I²C bus:

- One MUX (U_ICH_SPD) controls the DIMM SPDs through four split segments
- The other MUX (U_ICH_MAIN) controls the clock buffers, TOE, and USB Hub through four split segments.

Dell

BIOS controls both the MUXes through the two select lines using GPIO pins.

The clock chip, USB hub, and the front panel EEPROM device addresses are located on the IOH I²C bus.

10 Embedded NICs/LAN on Motherboard (LOM)

The PowerEdge R710 has embedded Gigabit Ethernet Controllers with TCP Offload Engine (TOE) support. Two embedded Broadcom® 5709C dual-port LAN controllers are on the R710 planar as independent Gigabit Ethernet interface devices. The following information details the features of the LAN devices:

- x4 PCI Express Gen2 capable interface (R710 operates this controller at Gen1 speed)
- Integrated MAC and PHY 3072x18 Byte context memory
- 64 KB receive buffer
- TOE (TCP Offload Engine)
- iSCSI controller (enabled through an optional hardware key)
- RDMA controller (RNIC) (enabled through optional hardware key)
- NC-SI (Network Controller-Sideband Interface) connection for manageability
- Wake-On-LAN (WOL)
- PXE 2.0 remote boot
- iSCSI boot
- IPv4 and IPv6 support
- Bare metal deployment support

11 PCI Slots

11.1 Overview

The PowerEdge R710 has two PCI Express risers: Riser 1 and Riser 2. Each riser connects to the planar through a x16 PCI Express connector.

- Riser 1 consists of two x4 slots and a third x4 slot dedicated for internal SAS storage through the PERC 6i or SAS 6/iR.
- The default Riser 2 consists of two x8 PCI Express connectors.
- There is also an optional x16 Riser 2 that supports one x16 PCI Express card.

To ensure proper cooling, no more than two of the four expansion cards can have a power consumption of greater than 15W (up to 25W maximum each), not including the integrated storage controller.

The system does not support hot-plug or hot-removal of PCI Express cards.

For more information on installing expansion cards and expansion-card priority, see the Expansion Cards and Expansion-Card Risers section in the Installing System Components chapter of the *Dell PowerEdge R710 Systems Hardware Owner's Manual* on Support.dell.com.

11.2 PCI Express Risers

The two PCI Express risers provide up to four expansion slots and one slot dedicated for the integrated storage controller card. The slots meet the following requirements:

- Two x8 and two x4 PCI Express Gen2 slots, each connected to the IOH
- One x4 PCI Express Gen1 slot for internal storage connected to the IOH
- Support for three full-height 9.5"-long PCI Express cards and one full-height bracket, low-profile PCB PCI Express card
- Support for customer installation of a full-length 12.2" PCI Express card in Slot 1 on Riser 1
- System support for 25 W maximum power for the first two cards and 15 W for the third and fourth cards (lower power support on third and fourth cards due to system thermal limitations)
- Optional x16 riser to accommodate interface cards for external GPU boxes that supports a maximum power of 25W (use of riser reduces the number of PCI Express slots from four to three)

The following riser restrictions apply for the R710:

- The riser connectors on the planar do not support plugging in a standard PCI Express card.
- Two R710 risers must be installed or the system will not power up.

11.3 Express Card Specifications (x16)

For information about x16 PCIe card specifications, see the Expansion Cards and Expansion-Card Risers section in the Installing System Components chapter in the *Dell PowerEdge R710 Systems Hardware Owner's Manual* on Support.Dell.com.

11.4 Quantities and Priorities

Refer to the Expansion Cards and Expansion-Card Risers section in the Installing System Components chapter of the *Dell PowerEdge R710 Systems Hardware Owner's Manual* on Support.dell.com.

Dell

11.5 PCI Card Dimensions

For information about PCIe slots and card dimensions, see the Expansion Cards and Expansion-Card Risers section in the Installing System Components chapter in the *Dell PowerEdge R710 Systems Hardware Owner's Manual* on Support.Dell.com.

12 Storage

12.1 Overview

The R710 supports three of the following backplanes to support different hard drive configurations:

- Four 3.5" hard drives
- Six 3.5" hard drives
- Eight 2.5" hard drives

On each backplane are two LED indicators per drive slot with one or two mini-SAS x4 cable connectors for connecting the backplane to the integrated SAS 6/iR or PERC 6i card and a power connector to connect to the planar. Both Serial Attached SCSI (SAS) and Serial ATA (SATA) hard drives are supported. SAS/SATA mixing and the use of 2.5" drives in a 3.5" chassis are supported.

12.2 Internal Hard Disk Drives

The PowerEdge R710 supports up to eight 2.5" hard drives or up to six 3.5" hard drives. See Table 10 for information on supported hard drives. For the most up-to-date information on supported hard drives, visit Dell.com.

Table 10. Supported Hard Drives

Form Factor	Capacity	Speed	Type
3.5"	250GB, 500GB, 1TB, 2TB	7.2K	SATA
3.5"	500GB, 1TB, 2TB	7.2K	NL SAS
3.5"	600GB	10K	SAS
3.5"	146GB, 300GB, 450GB, 600GB	15K	SAS
2.5"	160GB, 250GB, 500GB, 1TB	7.2K	SATA
2.5"	500GB, 1TB	7.2K	NL SAS
2.5"	146GB, 300GB, 600GB	10K	SAS
2.5"	73GB, 146GB, 300GB	15K	SAS
2.5"	50GB, 100GB	N/A	SATA SSD
2.5"	149GB	N/A	SAS SSD

The following additional guidelines apply for hard-drive configurations:

- For SAS/SATA mixing:
 - Two SAS and up to six SATA drives are allowed
 - Two SAS drives must be installed in slots 0 and 1
- One mixed 2.5" and 3.5" hard drive configuration is allowed:
 - Two 2.5" 10,000 rpm SAS drives installed with an adapter in a 3.5" hard-drive carrier in drive slots 0 and 1
 - The remaining hard drives must be 3.5" hard drives and must be either all SAS or all SATA
- SSDs require the PERC 6/i or PERC H700 integrated storage controller card and cannot be mixed with any other type of hard drive
- Limited SSD and SAS mixing is supported

12.2.1 Diskless Configuration Support

The system supports diskless configuration with no storage controller (SAS 6/iR, PERC 6i, PERC H200, or PERC H700) installed in the system. A 3.5” hard-drive backplane is still installed in this configuration.

12.2.2 Hard Drive LED Indicators

Each disk drive carrier has two LED indicators visible from the front of the system. One is a green LED for disk activity and the other is a bicolor (green/amber) LED for status information. The activity LED is driven by the disk drive during normal operation. The bicolor LED is controlled by the storage enclosure processor (SEP) device on the backplane. Both LEDs are used to indicate certain conditions under direction of a storage controller.

For more information, see the Hard-Drive Indicator Patterns section in the About Your System chapter in the *Dell PowerEdge R710 Systems Hardware Owner’s Manual* on Support.Dell.com.

12.3 RAID Configurations

See Table 11 for information on factory RAID configurations. For information on additional configurations, visit Dell.com.

Table 11. Factory RAID Configurations

Config Type	Configs		Description	Non-Mixed drives all SATA, all SAS, or all SSD	
				Min HDD	Max HDD
No HDD	0	NZC	No controller/No hard drive	2.5” = 0	2.5” = 0
SAS or SATA—No RAID	1	MSS	Integrated SAS/SATA (SAS 6/iR, PERC 6/i, PERC H200, or PERC H700), No RAID	2.5” = 1 3.5” = 1	2.5” = 8 3.5” = 6
SAS or SATA— RAID	2	MSSR0	Integrated SAS/SATA RAID 0 (SAS 6/iR, PERC 6/i, PERC H200, or PERC H700)	2.5” = 2 3.5” = 2	2.5” = 8 3.5” = 6
SAS or SATA— RAID	3	MSSR1	Integrated SAS/SATA RAID 1 (SAS 6/iR, PERC 6/i, PERC H200, or PERC H700)	2.5” = 2 3.5” = 2	2.5” = 2 3.5” = 2
	4	MSSR5	Integrated SAS/SATA RAID 5 (PERC 6/i, PERC H700)	2.5” = 3 3.5” = 3	2.5” = 8 3.5” = 6
	5	MSSR10	Integrated SAS/SATA RAID 10 (PERC 6/i, PERC H700)	2.5” = 4 3.5” = 4	2.5” = 8 3.5” = 6
	6	MSSR0/R0	Integrated SAS/SATA RAID 0/RAID 0 (SAS 6/iR, PERC 6/i, PERC H200, or PERC H700)	2.5” = 1 + 1 3.5” = 1 + 1	2.5” = 8 3.5” = 6

			<u>Non-Mixed drives</u> all SATA, all SAS, or all SSD		
Config Type	Configs		Description	Min HDD	Max HDD
SAS or SATA—RAID	7	MSSR1/R1	Integrated SAS/SATA RAID 1/RAID 1 (SAS 6/iR, PERC 6/i, PERC H200, or PERC H700)	2.5" = 2 + 2 3.5" = 2 + 2	2.5" = 2 + 2 3.5" = 2 + 2
	8	MSSR1/R5	Integrated SAS/SATA RAID 1/RAID 5 (PERC 6/i, PERC H700)	2.5" = 2 + 3 3.5" = 2 + 3	2.5" = 2 + 6 3.5" = 2 + 4
	9	MSSR1/R10	Integrated SAS/SATA RAID 1/RAID 10 (PERC 6/i, PERC H700)	2.5" = 2 + 4 3.5" = 2 + 4	2.5" = 2 + 6 3.5" = 2 + 4
	10	MSSR6	Integrated SAS/SATA RAID 6 (PERC 6/i, PERC H700)	2.5" = 4 3.5" = 4	2.5" = 8 3.5" = 6
SAS or SATA SSDs—RAID	16	MSSR1	Integrated SSD RAID 1 (PERC 6/i, PERC H700)	2.5" = 2	2.5" = 2
	17	MSSR5	Integrated SSD RAID 5 (PERC 6/i, PERC H700)	2.5" = 3	2.5" = 8
	18	MSSR10	Integrated SSD RAID 10 (PERC 6/i, PERC H700)	2.5" = 4	2.5" = 8
			<u>Mixed SATA + SAS</u> Min 2xSAS + 1xSATA 2.5": Max 2xSAS + 6xSATA 3.5": Max 2xSAS + 4xSATA		
Config Type	Configs		Description	Min HDD	Max HDD
SAS + SATA—No RAID	11	MSS-X	Integrated SAS/SATA (SAS 6/iR, PERC 6/i, PERC H200, or PERC H700), No RAID	2.5" = 3 3.5" = 3	2.5" = 6 3.5" = 4
SAS + SATA—RAID	12	MSSR0/R0-X	Integrated SAS/SATA RAID 0/RAID 0 (SAS 6/iR, PERC 6/i, PERC H200, or PERC H700)	2.5" = 2 3.5" = 2	2.5" = 6 3.5" = 4
	13	MSSR1/R1-X	Integrated SAS/SATA RAID 1/RAID 1 (SAS 6/iR, PERC 6/i, PERC H200, or PERC H700)	2.5" = 2 + 2 3.5" = 2 + 2	2.5" = 2 + 2 3.5" = 2 + 2
	14	MSSR1/R5-X	Integrated SAS/SATA RAID 1/RAID 5 (PERC 6/i, PERC H700)	2.5" = 2 + 3 3.5" = 2 + 3	2.5" = 2 + 6 3.5" = 2 + 4

				<u>Mixed SATA + SAS</u> Min 2xSAS + 1xSATA 2.5": Max 2xSAS + 6xSATA 3.5": Max 2xSAS + 4xSATA	
Config Type	Configs		Description	Min HDD	Max HDD
	15	MSSR1/R10-X	Integrated SAS/SATA RAID 1/RAID 10 (PERC 6/i, PERC H700)	2.5" = 2 + 4 3.5" = 2 + 4	2.5" = 2 + 6 3.5" = 2 + 4
				<u>Mixed SSD + SAS</u> Min 2xSSD + 2xSAS Max 2xSSD + 6xSAS	
Config Type	Configs		Description	Min HDD	Max HDD
SAS or SATA SSD + SAS RAID	19	MSSR1/R1-X	Integrated SSD/SAS RAID 1/RAID 1 (PERC 6/i, PERC H700)	2.5" = 2 + 2	2.5" = 2 + 2
	20	MSSR1/R5-X	Integrated SSD/SAS RAID 1/RAID 5 (PERC 6/i, PERC H700)	2.5" = 2 + 3	2.5" = 2 + 6
	21	MSSR1/R10-X	Integrated SSD/SAS RAID 1/RAID 10 (PERC 6/i, PERC H700)	2.5" = 2 + 4	2.5" = 2 + 6

12.4 Storage Controllers

12.4.1 SAS 6/iR

The R710 internal SAS 6/iR HBA is an expansion card that plugs into a dedicated PCI Express x8 slot (four lanes wired). It incorporates two four-channel SAS IOCs for connection to SAS or SATA hard disk drives. It is designed in a form factor that allows the same card to be used in the PowerEdge R610 and PowerEdge T610.

12.4.2 PERC 6/i

If you want an internal RAID solution, select the PERC 6/i or PERC H700. The PERC 6/i uses the LSI 1078 ROC (RAID on Chip) processor with a PCI Express host interface and DDR2 memory. A battery is also available for backup.

12.4.3 PERC H200

The H200 SAS HBA is an expansion card that plugs into the dedicated internal SAS slot on Riser1. It incorporates two four-channel 6 Gb/s SAS IOCs for connection to SAS hard disk drives. It is designed in a form factor that allows the same card to be used in other 11G 2U rack-form factor platforms.

12.4.4 PERC H700

If you want an internal RAID solution, select the PERC H700 or PERC 6/i. The PERC H700 card has its own processor with a PCI Express Gen2 host interface and DDR2 memory and installs into the dedicated internal SAS slot on Riser1. A battery is also available for backup. It supports the internal 6 Gb/s backplane interface for internal storage options (SAS, SATA, or SSD HDD). The PowerEdge R710 supports both 256MB and 512MB cache options on the internal H700.

Table 12. Storage Card Support Matrix

	Product	Usage	PowerEdge R710 Support	Slot	PCI Con	PCI Bracket	IO Con	RAID	Battery Backup
PERC SAS/SATA	PERC 6/i Integrated (PERC H700)	Internal Backplane Storage RAID (HDD, SDD)	Yes—Max 1	Storage slot	x8	No	x4 int x4 int	0, 1, 5, 6, 10, 50, 60	Yes
	PERC 6/E Adapter (PERC H800)	External SAS/SATA storage	Yes—Max 2 (MD1000 and MD1020)	PCIe slot	x8	Yes	x4 ext x4 ext	0, 1, 5, 6, 10, 50, 60	Yes
	PERC 5/E Adapter	Legacy external storage	Yes—Max 2 (MD1020)	PCIe slot	x8	Yes	x4 ext x4 ext	0, 1, 5, 10, 50	Yes
SAS HBA SAS/SATA	SAS 6/iR Integrated (PERC H200)	Internal backplane storage (No tape or SSD support)	Yes—Max 1	Storage slot	x8	No	x4 int x4 int	0, 1	No
	SAS 5/E Adapter (SAS 6G HBA)	External SAS (DAS, tape)	Yes—Max 2	PCIe slot	x8	Yes	x4 ext x4 ext	None	No
ICH9	On planar via chipset	Internal slimline SATA optical and/or tape backup only (no HDD)	Yes—2 ports for optical and/or TBU	N/A	N/A	N/A	x1 int	N/A	N/A
LSI 2032 SCSI	LSI 2032 Adapter	Internal or external SCSI tape/ legacy external storage	Yes—Max 2	PCIe slot	x8	Yes	SCSI int SCSI ext	N/A	N/A

A maximum of 2 external storage controllers (Dell PERC or SAS cards) are allowed in the system in addition to the integrated storage controller.

12.5 Optical Drives

Optical drives are optional in all PowerEdge R710 systems and connect to the planar through the SATA interface. The following internal slimline drives are available on the PowerEdge R710:

- DVD-ROM
- DVD+RW

If an optical drive is not ordered with the system, a blank is installed in its place.

12.6 Tape Drives

External tape drives and tape libraries are supported. For more information on supported tape drives and tape libraries, see <http://www.dell.com/storage>.

12.7 External Storage Support

External storage devices are supported. For more information, see <http://www.dell.com/storage>.

13 Video

The PowerEdge R710 Integrated Dell Remote Access Controller 6 (iDRAC6) incorporates an integrated video subsystem, connected to the 32-bit PCI interface of the ICH9. This logic is based on the Matrox® G200. The device only supports 2D graphics. The video device outputs are multiplexed between the front and rear video ports. If a monitor is connected to the front video connector, it will take precedence over the rear connection, thereby removing the display from the rear connection. The integrated video core shares its video memory with the iDRAC6's 128 MB DDR2 application space memory. This memory is also used for the KVM buffer. The resolutions supported are listed in Table 13.

Table 13. Graphics Video Modes

Resolution	Refresh Rate (Hz)	Color Depth (bit)
640 x 480	60, 72, 75, 85	8, 16, 32
800 x 600	56, 60, 72, 75, 85	8, 16, 32
1024 x 768	60, 72, 75, 85	8, 16, 32
1152 x 864	75	8, 16, 32
1280 x 1024	60, 75, 85	8, 16
1280 x 1024	60	32

14 Rack Information

14.1 Overview

The ReadyRails™ sliding and static rail systems for the R710 provide toolless support for 4-post racks with square or unthreaded round mounting holes including all generations of Dell racks. Both rail systems support toolled mounting in 4-post threaded racks (an optional adapter brackets kit is required for the sliding rails). The static rails also providing toolled mounting support for 2-post (Telco) racks for added versatility. The optional cable management arm (CMA) can be mounted on either the left or right side of the sliding rails without the use of tools for fast and easy deployment.

The R710 is not compatible with any other Dell rails including previous generation rails, but it does use the same static rails as the R610.

14.2 Rails

The rail offerings for the R710 consist of two types: sliding and static.

The sliding rails allow the system to be fully extended out of the rack for service and are available with or without the optional cable management arm (CMA).

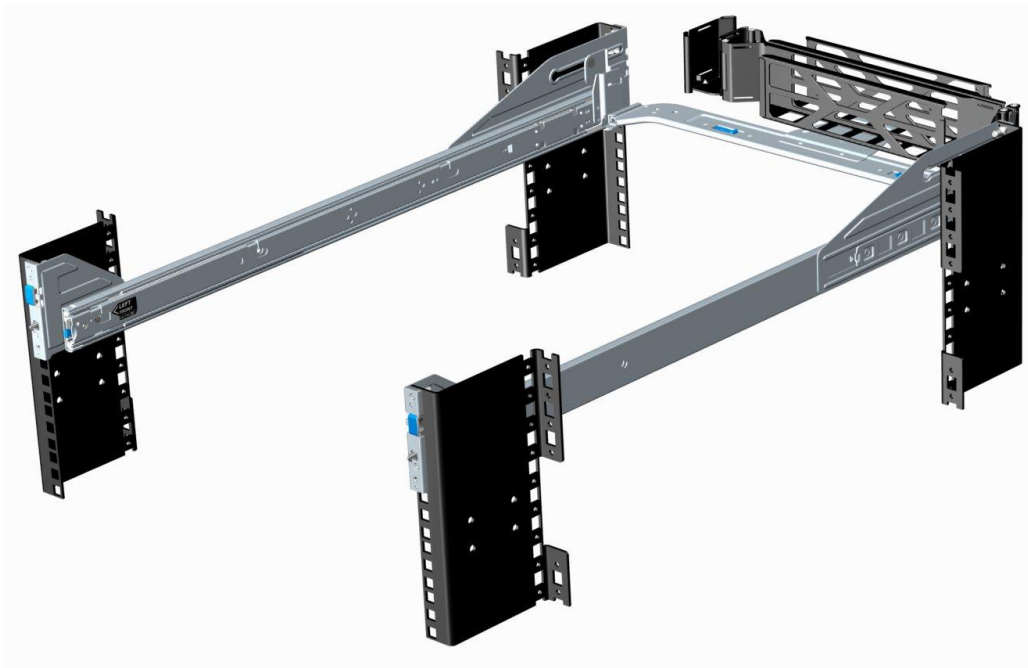

Figure 11. R710 Sliding Rails with Optional CMA

Sliding rail kits can be used in a threaded-hole rack only if threaded rack adapter brackets are installed (see Figure 12). The threaded rack adapter brackets are first mounted to the EIA flanges in the rack, and the sliding rails are mounted into the brackets. The design of the brackets has been optimized to limit the forward shift of the system in the rack to only 17.3 mm.

The adapter brackets kit includes six brackets to accommodate different rail lengths, plus four sets of custom screws in common thread sizes. A detailed *Getting Started Guide* is included in the kit along with directions for installing the brackets and mounting the rails into the brackets.

Depending on the depth of the rack used, it may be necessary to remove the server's bezel in order to close the door of the rack. A minimum of 58 mm is needed between the back surface of the door panel and the front face of the EIA flange for the front door to close with the 11G server bezel installed.

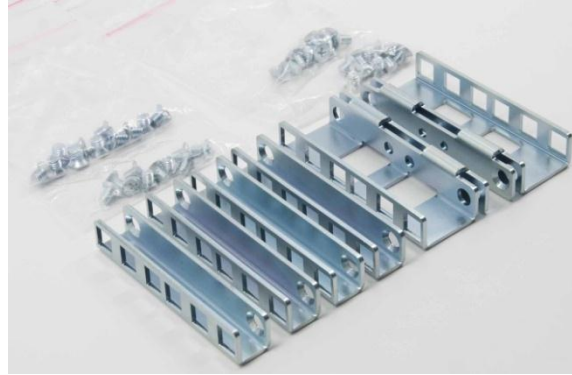

Figure 12. 2U Threaded Rack Adapter Brackets Kit

The static rails support a wider variety of racks than the sliding rails but do not support serviceability in the rack and are not compatible with the CMA.



Figure 13. R710 Static Rails

One key factor in selecting the proper rails is identifying the type of rack in which they will be installed. Both the sliding rails and the static rails support toolless mounting in 19"-wide, EIA-310-E compliant 4-post racks, but only the static rails, as the more generic or universal solution, support mounting in threaded hole and 2-post (Telco) racks.

Table 14. Supported Racks

Product	Rail ID	Mounting Interface	Rail Type	Rack Types Supported				
				4-Post			2-Post	
				Square	Round	Thread	Flush	Center
R710	B1	ReadyRails™	Sliding	✓	✓	✓*	X	X
	A2	ReadyRails™/Generic	Static	✓	✓	✓	✓	✓

*Requires the 2U Threaded Rack Adapter Brackets Kit (Dell part number PKCR1)

Dell

Screws are not included in the static rail kit because threaded racks are offered with a variety of thread designations. Users must provide their own screws when mounting the static rails in threaded or 2-post racks.

Other key factors governing proper rail selection include the spacing between the front and rear mounting flanges of the rack, the type and location of any equipment mounted in the back of the rack such as power distribution units (PDUs), and the overall depth of the rack. See Table 15.

Due to their reduced complexity and lack of need for CMA support, the static rails offer a greater adjustability range and an overall smaller footprint than the sliding rails.

Table 15. Rail Adjustability Ranges and Depth

Product	Rail ID	Mounting Interface	Rail Type	Rail Adjustability Range (mm)						Rail Depth (mm)	
				Square		Round		Threaded		Without CMA	With CMA
				Min	Max	Min	Max	Min	Max		
R710	B1	ReadyRails™	Sliding	692	756	678	749	657	770	751	840
	A2	ReadyRails™/ Generic	Static	588	828	574	821	592	846	608	N/A

The adjustment range of the rails is a function of the type of rack in which they are being mounted. The min-max values listed above represent the allowable distance between the front and rear mounting flanges in the rack. Rail depth represents the minimum depth of the rail as measured from the rack front mounting flanges when the rail rear bracket is positioned all the way forward.

14.3 Cable Management Arm (CMA)

The optional cable management arm (CMA) for the R710 organizes and secures the cords and cables exiting the back of the server and unfolds to allow the server to extend out of the rack without having to detach the cables. Some key features of the R710 CMA include:

- Large U-shaped baskets support dense cable loads.
- An open vent pattern allows for optimal airflow.
- The CMA mounting is fully-reversible (can be mounted on either side) with no conversion required.
- Hook-and-loop straps are used rather than plastic tie wraps to eliminate the risk of cable damage during cycling.
- A low-profile fixed tray is provided to both support and retain the CMA in its fully closed position.
- The CMA and the tray mount without the use of tools using simple and intuitive snap-in designs.

14.4 Rack View

The R710 ReadyRails sliding rails are a drop-in design, meaning that the system is installed vertically into the rails by inserting the shoulder nuts on the sides of the system into the J-slots in the inner rail members with the rails in the fully extended position. See Figure 14.



Figure 14. R710 Mounted in B1 Sliding Rails

The CMA can be mounted to either side of the rails without the use of tools or the need for conversion, but it is recommended that it be mounted on the side opposite the power supplies to allow easier access to the power supplies for service or replacement. See Figure 15.



Figure 15. R710 Mounted in the B1 Sliding Rails with the CMA

The R710 static rails essentially function like a fixed shelf. The system is installed by resting the back of the system on the inner ledges of the rail front brackets, then pushing the system forward while ensuring that the shoulder nuts on the sides of the system are properly engaged in the horizontal slots on the rails. See Figure 16.



Figure 16. R710 Mounted in the A2 Static Rails (2-post Center Mount Configuration)

15 Operating Systems

For detailed information, see the following:

- [Operating System Support Matrix for Dell PowerEdge Systems](#) on www.Dell.com
- *Dell PowerEdge R710 Systems Getting Started With Your System* guide on Support.Dell.com

16 Systems Management

16.1 Overview

Dell delivers open, comprehensive, and integrated solutions that help you reduce the complexity of managing disparate IT assets. Combining Dell PowerEdge Servers with a wide selection of Dell developed systems management solutions gives you choice and flexibility, so you can simplify and save in IT environments of any size. To help you meet your server management demands, Dell offers Dell OpenManage™ systems management solutions for:

- Deployment of one or many servers from a single console
- Monitoring of server and storage health and maintenance
- Update of system, operating system, and application software

Dell offers IT management solutions for organizations of all sizes—priced and sized appropriately and supported comprehensively.

16.2 Server Management

A Dell Systems Management and Documentation DVD and a Dell Management Console DVD are included with the product. ISO images are also available. A brief description of available content:

- **Dell Systems Build and Update Utility (SBUU):** Dell Systems Build and Update Utility assists in OS install and pre-OS hardware configuration and updates.
- **Server Update Utility (SUU):** This DVD has an inventory tool for managing updates to firmware, BIOS, and drivers for either Linux® or Microsoft® Windows® varieties.
- **OpenManage Server Administrator (OMSA):** The OpenManage Server Administrator tool provides a comprehensive, one-to-one (one console to one server) systems management solution, designed for system administrators to manage systems locally and remotely over a network. OMSA allows system administrators to focus on managing their entire network.
- **Management Console:** Dell IT Assistant (ITA) is also included, as well as tools to allow access to our remote management products. These tools are Remote Access Service for iDRAC, and the Baseboard Management Controller (BMC) Utility.
- **Active Directory Snap-in Utility:** The Active Directory Snap-in Utility provides an extension snap-in to the Microsoft® Active Directory. This allows you to manage Dell specific Active Directory objects. The Dell-specific schema class definitions and their installation are also included on the DVD.
- **Dell Systems Service Diagnostics Tools:** Dell Systems Service and Diagnostics tools deliver the latest Dell optimized drivers, utilities, and operating system-based diagnostics that you can use to update your system.
- **eDocs:** The section includes PDF files for PowerEdge systems, storage peripherals, and OpenManage software.
- **Dell Management Console (DMC):** The Dell Management Console is a systems management console that enables systems administrators to discover and inventory devices on your network. It provides functions such as health and performance monitoring of networked devices, and patch management capabilities for Dell systems. DMC differs from the IT Assistant management console (described above) in that with DMC, value-add plug-ins that enable advanced functionality can be purchased and added to the base DMC product.

16.3 Embedded Server Management

The PowerEdge R710 implements circuitry for the next generation of Embedded Server Management. It is Intelligent Platform Management Interface (IPMI) v2.0 compliant. The iDRAC (Integrated Dell Remote Access Controller) is responsible for acting as an interface between the host system and its management software and the periphery devices.

iDRAC6 provides features for managing the server remotely or in data center lights-out environments. Advanced iDRAC features require the installation of the optional iDRAC6 Enterprise card.

16.4 Dell Lifecycle Controller and Unified Server Configurator

Embedded management is comprised of interdependent pieces:

- Dell Lifecycle Controller
- Unified Server Configurator
- iDRAC6

Dell Lifecycle Controller powers the embedded management features. It is integrated and tamper-proof storage for system-management tools and enablement utilities (firmware, drivers, etc.). Lifecycle Controller enables pre-OS server deployment, OS installation, platform updates, platform configuration, and diagnostics capabilities.

Dell Unified Server Configurator (USC) is a graphical user interface (GUI) that aids in local server provisioning in a pre-OS environment. To access the Unified Server Configurator, press the <F10> key within 10 seconds of the Dell logo's appearance during the system boot process. Current functionality enabled by the Unified Server Configurator includes those shown in Table 16.

Table 16. Unified Server Configurator Features and Description

Feature	Description
Faster O/S Installation	Drivers and the installation utility are embedded on system, so no need to scour Dell.com
Faster System Updates	Integration with Dell support automatically directed to latest versions of the Unified Server Configurator, iDRAC, RAID, BIOS, NIC, and Power Supply
Update Rollback	Ability to recover to previous "known good state" for all updatable components
More Comprehensive Diagnostics	Diagnostic utilities are embedded on system
Simplified Hardware Configuration	Detects RAID controller and allows user to configure virtual disk and choose virtual disk as boot device, eliminating the need to launch a separate utility. Also provides configuration for iDRAC, BIOS, and NIC/LOM.

16.5 Integrated Dell Remote Access Controller

The integrated Dell Remote Access Controller (iDRAC6) provides IT Administrators comprehensive yet straightforward management of remote servers, by delivering "as if you are there" presence and control. iDRAC6 helps users to save time and money by eliminating travel to the remote server(s), whether that server is located in a different room, a different building, a different city, or in a different country.

Dell

iDRAC6 is a purchasable option and is available as three offerings: iDRAC6 Express, iDRAC6 Enterprise, and Virtual Flash (vFlash) media:

- iDRAC6 Express is most appropriate for SMB customers with limited remote management needs.
- iDRAC6 Enterprise is appropriate for large data center customers with distributed servers.
- iDRAC6 with vFlash Media is provided for large enterprise customers with requirements for system management automation.

16.6 iDRAC6 Express

The iDRAC6 Express is standard on the PowerEdge R710. In addition to providing a Lifecycle Controller, the iDRAC6 Express offers the following key features:

- Graphical web interface
- Standard-based interfaces
- Server Sensor monitoring and fault alerting
- Secure operation of remote access functions including authentication, authorization, and encryption
- Power control and management with the ability to limit server power consumption and remotely control server power states
- Advanced troubleshooting capabilities

For more information on iDRAC6 Express features see Table 17.

16.7 iDRAC6 Enterprise

The optional iDRAC6 Enterprise card provides access to advanced iDRAC6 features. The iDRAC6 Enterprise connects directly to the R710 planar and is mounted parallel to the planar with stand-offs.

Key features for the iDRAC6 Enterprise include:

- Scripting capability with Dell's racadm command line
- Remote video, keyboard, and mouse control with Virtual Console
- Remote media access with Virtual Media
- Dedicated network interface

16.8 iDRAC6 Enterprise with Virtual Flash (vFlash) Media

The iDRAC6 Enterprise can be upgraded by adding the vFlash Media card. This is an 8GB Dell branded SD card that enables a persistent 256 MB virtual flash partition. The vFlash Media delivers the following key features:

- Support for 8GB SD storage media
- Can be used as a repository for a pre-OS image, eliminating the need to maintain a network infrastructure for OS deployment
- Can also be used for permanent diagnostics image for use after system failures, or permanent failsafe image for periodic configuration changes

A more detailed feature list for iDRAC6 Express, iDRAC6 Enterprise, and vFlash Media is shown in Table 17.

Table 17. Features List for Base Management Functionality, iDRAC6, and vFlash

Feature	Base Management Functionality	iDRAC6 Express	iDRAC6 Enterprise	vFlash Media
Interface and Standards Support				
IPMI 2.0	✓	✓	✓	✓
Web-based GUI		✓	✓	✓
SNMP		✓	✓	✓
WSMAN		✓	✓	✓
SMASH-CLP		✓	✓	✓
Racadm command-line			✓	✓
Conductivity				
Shared/Failover Network Modes	✓	✓	✓	✓
IPv4	✓	✓	✓	✓
VLAN Tagging	✓	✓	✓	✓
IPv6		✓	✓	✓
Dynamic DNS		✓	✓	✓
Dedicated NIC			✓	✓
Security and Authentication				
Role-based Authority	✓	✓	✓	✓
Local Users	✓	✓	✓	✓
Active Directory		✓	✓	✓
SSL Encryption		✓	✓	✓
Remote Management and Remediation				
Remote Firmware Update	✓	✓	✓	✓
Server power control	✓	✓	✓	✓
Serial-over-LAN (with proxy)	✓	✓	✓	✓
Serial-over-LAN (no proxy)		✓	✓	✓
Power capping		✓	✓	✓
Last crash screen capture		✓	✓	✓
Boot capture		✓	✓	✓
Serial-over-LAN		✓	✓	✓

Feature	Base Management Functionality	iDRAC6 Express	iDRAC6 Enterprise	vFlash Media
Virtual media			✓	✓
Virtual console			✓	✓
Virtual console sharing			✓	✓
Virtual flash				✓
Monitoring				
Sensor Monitoring and Alerting	✓	✓	✓	✓
Real-time Power Monitoring		✓	✓	✓
Real-time Power Graphing		✓	✓	✓
Historical Power Counters		✓	✓	✓
Logging Features				
System Event Log	✓	✓	✓	✓
RAC Log		✓	✓	✓
Trace Log			✓	✓

17 USB Peripherals

The R710 supports the following USB devices:

- DVD (bootable; requires two USB ports)
- USB key (bootable)
- Keyboard (only one USB keyboard is supported)
- Mouse (only one USB mouse is supported)

Appendix A. Certifications

A.1 Regulatory Certifications

Regulatory compliance certificates can be located at the following sites:

- <http://ausreactorprd01/reactor/xCertSearch.asp>
- http://www.dell.com/content/topics/global.aspx/about_dell/values/regulatory_compliance/dec_conform?c=us&l=en&s=corp

A.2 Product Safety Certifications

The product has been certified and bears the Mark, as applicable, of the Product Safety authorities as indicated in Table 18.

Table 18. Product Safety Certifications

Country/Region	Authority or Mark
Argentina	IRAM
Belarus	BELLIS
Canada	SCC
China	CNCA or CCC
Croatia	KONCAR
European Union	CE
Germany	TUV
IECEE	IECEE CB
Israel	SII
Kazakhstan	OTAN - CKT
Kenya	KEBS
Kuwait	KUCAS
Mexico	NYCE or NOM
Moldova	INSM
Nigeria	SONCAP
Norway	NEMKO
Russia	GOST
Saudi Arabia	KSA ICCP
South Africa	NRCS
Taiwan	BSMI
Ukraine	UKRTEST or UKRSERTCOMPUTER
United States	NRTL
Uzbekistan	STZ

A.3 Electromagnetic Compatibility

The product has been certified and bears the Mark, as applicable, of the EMC authorities as indicated in Table 19.

Table 19. Electromagnetic Compatibility Certifications

Country/Region	Authority or Mark	Class
Australia/New Zealand	ACMA or C-Tick	Class A
Belarus	BELLIS	Class A
Bosnia & Herzegovina, Montenegro, Serbia	KVALITET	Class A
Canada	ICES	Class A
China	CNCA or CCC	Class A
Croatia	KONCAR	Class A
European Union	CE	Class A
Israel	SII	Class A
Japan	VCCI	Class A
Kazakhstan	OTAN - CKT	Class A
Moldova	INSM	Class A
Norway	NEMKO	Class A
Russia	GOST	Class A
South Africa	SABS	Class A
South Korea	KCC	Class A
Taiwan	BSMI	Class A
Ukraine	UKRTEST or UKRSERTCOMPUTER	Class A
United States	FCC	Class A
Uzbekistan	STZ	Class A
Vietnam	ICT	Class A

A.4 Ergonomics, Acoustics and Hygienics

The product has been certified and bears the Mark, as applicable, of the Ergonomics, Acoustics and Hygienics authorities as indicated in Table 20.

Table 20. Ergonomics, Acoustics and Hygienics

Country/Region	Authority or Mark
Belarus	BELLIS
Germany	GS
Russia	GOST

Appendix B. Additional Information and Options

PowerEdge R710 systems conform to the industry standards detailed in Table 21.

Table 21. Industry Standards

Standard	URL for Information and Specifications
ACPI Advance Configuration and Power Interface Specification, v2.0c	http://www.acpi.info/
Energy Star EPA Version 1.0 of the Computer Server specification	http://www.energystar.gov/index.cfm?c=archives.enterprise_servers
Ethernet IEEE 802.3-2005	http://standards.ieee.org/getieee802/802.3.html
IPMI Intelligent Platform Management Interface, v2.0	http://www.intel.com/design/servers/ipmi/
DDR3 Memory DDR3 SDRAM Specification, Rev. 3A	http://www.jedec.org/download/search/JESD79-3A.pdf
LPC Low Pin Count Interface Specification, Rev. 1.1	http://developer.AMD.com/design/chipsets/industry/lpc.htm
PCI Express PCI Express Base Specification Rev. 2.0	http://www.pcisig.com/specifications/pciexpress/
PMBus Power System Management Protocol Specification, v1.1	http://pmbus.info/specs.html
SAS Serial Attached SCSI, v1.1	http://www.t10.org/cgi-bin/ac.pl?t=f&f=sas1r10.pdf
SATA Serial ATA Rev. 2.6; SATA II, Extensions to SATA 1.0a, Rev. 1.2	http://sata-io.org/
SMBIOS System Management BIOS Reference Specification, v2.6	http://www.dmtf.org/standards/smbios/
TPM Trusted Platform Module Specification, v1.2	http://www.trustedcomputinggroup.org/resources/tpm_main_specification
UEFI Unified Extensible Firmware Interface Specification, v2.1	http://www.uefi.org/specs/

Dell

Standard	URL for Information and Specifications
USB Universal Serial Bus Specification, Rev. 2.0	http://www.usb.org/developers/docs/
Windows Logo Windows Logo Program System and Device Requirements, v3.10	http://www.microsoft.com/whdc/winlogo/hwrequirements.msp