

DELL™

OPTIPLEX™ 9010

TECHNICAL GUIDEBOOK

INSIDE THE OPTIPLEX 9010



TABLE OF CONTENTS

OVERVIEW	
Mini Tower Computer (MT) View	3-4
Desktop Computer (DT) View	5-6
Small Form Factor Computer (SFF) View	7-8
Ultra Small Form Factor Computer (USFF) View	9-10
MARKETING SYSTEM CONFIGURATIONS	
Operating System, Chipset	11
Processor	12
Memory	13
Drives and Removable Storage, System Board Connectors	14-15
Graphics/Video Controller	16
External Ports/Connectors	16
Communications—Network Adapter (NIC), Wireless	17
Audio and Speakers, Keyboard and Mouse	17
Security, Service and Support, Software	18
DETAILED ENGINEERING SPECIFICATIONS	
System Dimensions (Physical)	19
System Board Connector Maximum Allowable Dimensions	19
System Level Environmental and Operating Conditions	20
Power	21-22
Audio	23
Communications	23-28
Graphics/Video Controller	29-31
Hard Drives	32-39
Optical Drive	40-42
Media Card Reader	43
BIOS Defaults	44
Chassis Enclosure and Ventilation Requirements	45
Acoustic Noise Emission Information	46-49

MINI TOWER COMPUTER (MT) VIEW

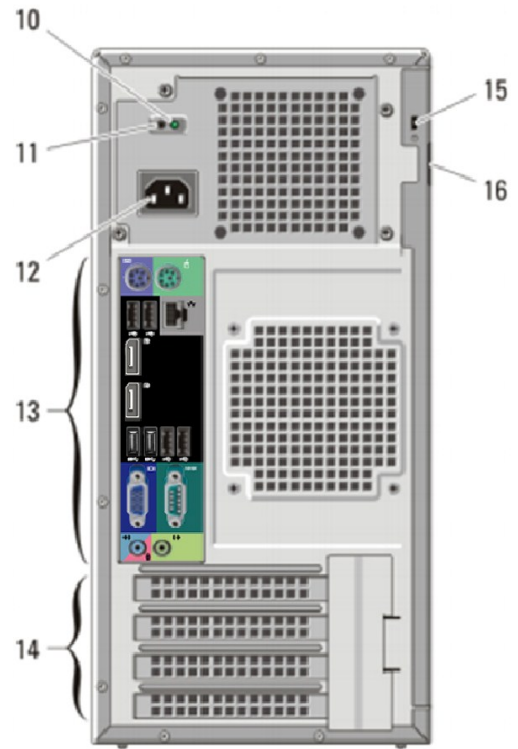
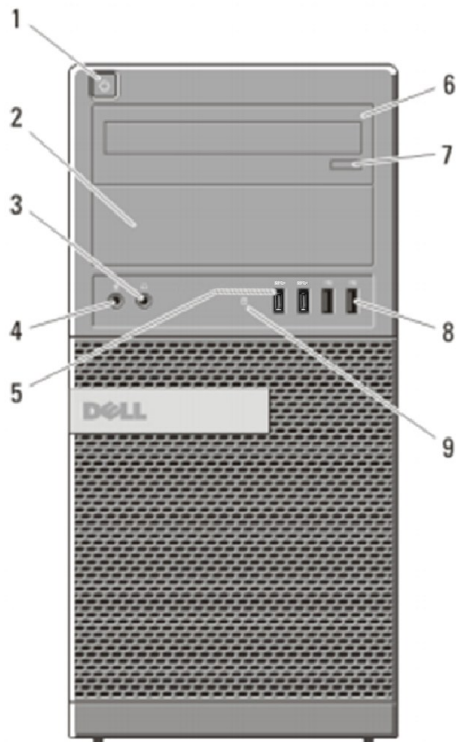

FRONT VIEW			
1	Power Button, Power Light	6	Optical Drive (optional)
2	Optical Drive Bay (optional)	7	Optical Drive Eject Button
3	Headphone Connector	8	USB 2.0 Connectors (2)
4	Microphone Connector	9	Drive Activity Light
5	USB 3.0 Connectors (2)		

BACK VIEW			
10	Power Supply Diagnostic Light	14	Expansion Card Slots (4)
11	Power Supply Diagnostic Button	15	Kensington / Noble Security Cable Slot
12	Power Connectors	16	Padlock Ring
13	Back Panel Connectors		

BACK PANEL CONNECTORS			
1	PS2 Mouse Connector	7	PS2 Keyboard Connector
2	Link Integrity Light	8	USB2.0 Connectors (2)
3	Network Connector	9	DisplayPort Connector (2)
4	Network Activity Light	10	USB2.0 Connectors (2) USB3.0 Connectors (2)
5	Serial Connector	11	VGA Connector
6	Line-out Connector	12	Line-in/Microphone Connector

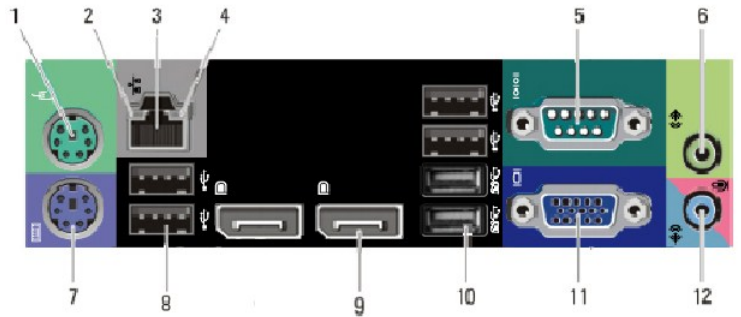

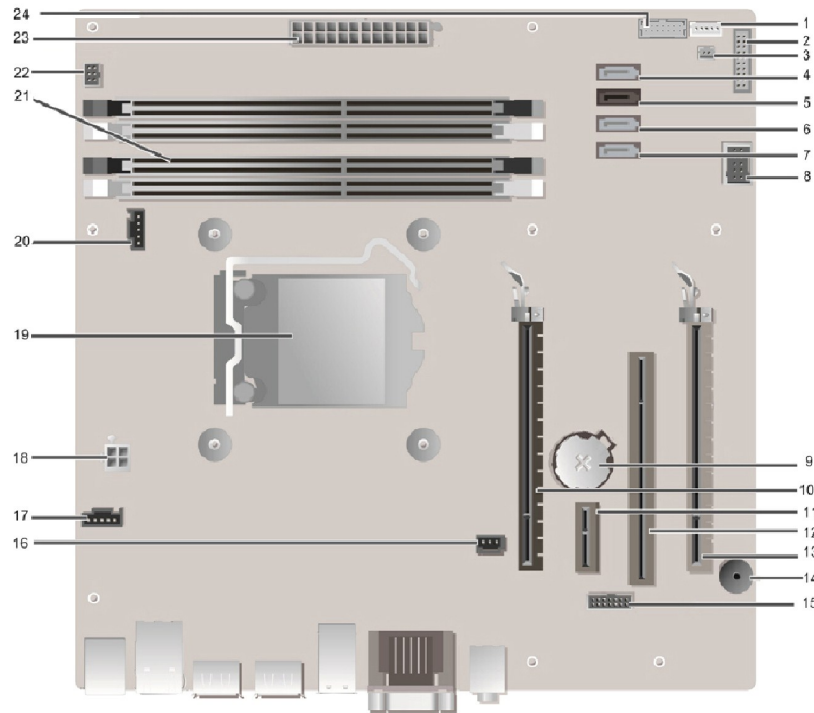

MT System Board Components

Num-ber	Name	Num-ber	Name
1	Internal Speaker Connector (INT_SPKR)	13	PCI-e x16 (wire x4) Connector (SLOT4)
2	Front IO Connector (FRONTPANEL)	14	Buzzer (BEEP)
3	Thermal Sensor Connector (THRM_2)	15	LPC Debug Connector (LPC_DEBUG)
4	SATA 0 Connector (SATA0)	16	Intrusion Switch Connector (INTRUDER)
5	SATA 1 Connector (SATA1)	17	System Fan Connector (FAN_HDD)
6	SATA 2 Connector (SATA2)	18	P2 Power Connector (12V_PWRCONN)
7	SATA 3 Connector (SATA3)	19	Processor Socket (N/A)
8	Internal USB Connector (INT_USB)	20	CPU fan Connector (FAN_CPU)
9	Battery Connector (BATTERY)	21	Memory Connectors (DIMM1, DIMM2, DIMM3, DIMM4)
10	PCI-e x16 Connector (SLOT1)	22	Power Switch Connector (PWR_SW)
11	PCI-e x1 Connector (SLOT2)	23	P1 Power Connector (POWER)
12	PCI Connector (SLOT3)	24	Front USB3.0 Connector (Front_USB)

DESKTOP COMPUTER (DT) VIEW

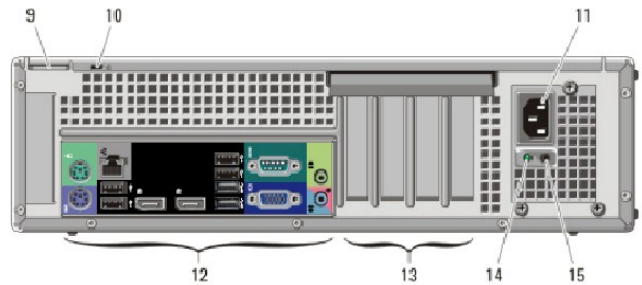
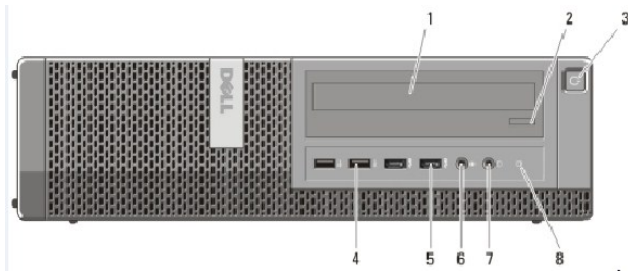

FRONT VIEW			
1	Optical Drive	5	USB 3.0 Connectors (2)
2	Optical Drive Eject Button	6	Microphone Connector
3	Power Button, Power Light	7	Headphone Connector
4	USB 2.0 Connectors (2)	8	Drive Activity Light

BACK VIEW			
9	Padlock Ring	13	Expansion Card Slots (4)
10	Kensington / Noble Security Cable Slot	14	Power Supply Diagnostic Light
11	Power Connectors	15	Power Supply Diagnostic Button
12	Back Panel Connectors		

BACK PANEL CONNECTORS			
1	PS2 Mouse Connector	7	PS2 Keyboard Connector
2	Link Integrity Light	8	USB2.0 Connectors (2)
3	Network Connector	9	DisplayPort Connector (2)
4	Network Activity Light	10	USB2.0 Connectors (2) USB3.0 Connectors (2)
5	Serial Connector	11	VGA Connector
6	Line-out Connector	12	Line-in/Microphone Connector

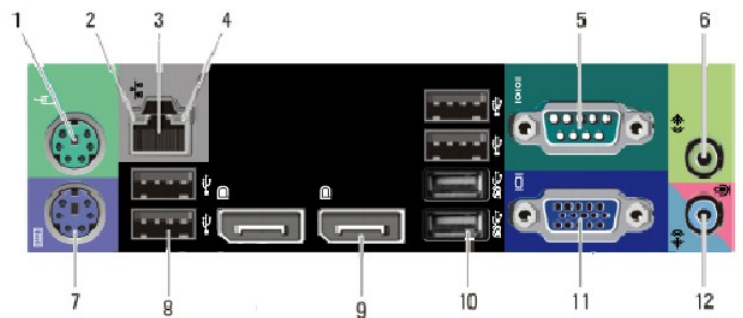

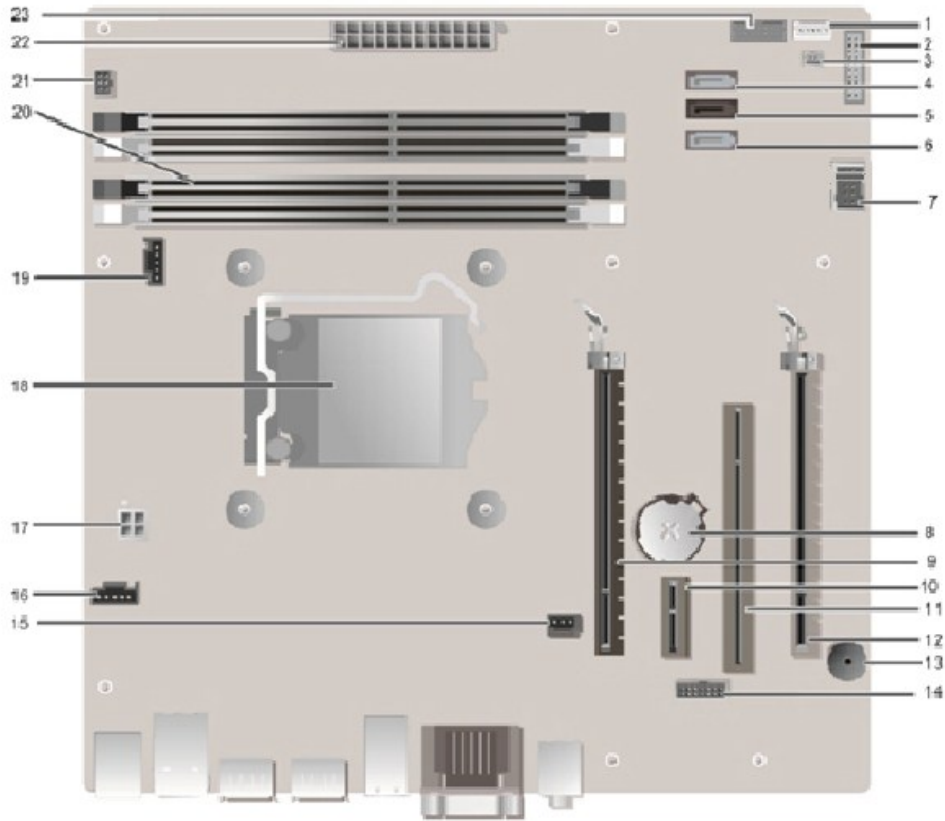

DT System Board Components

Number	Name	Number	Name
1	Internal Speaker Connector (INT_SPKR)	12	PCI-ex 16 (wire x4) Connector (SLOT4)
2	Front IO Connector (FRONTPANEL)	13	Buzzer (BEEP)
3	Thermal Sensor Connector (THRM_2)	14	LPC Debug Connector (LPC_DEBUG)
4	SATA 0 Connector (SATA0)	15	Intrusion Switch Connector (INTRUDER)
5	SATA 1 Connector (SATA1)	16	System Fan Connector (FAN_HDD)
6	SATA 2 Connector (SATA2)	17	P2 Power Connector (12V_PWRCONN)
7	Internal USB Connector (INT_USB)	18	Processor Socket (N/A)
8	Battery Connector (BATTERY)	19	CPU fan Connector (FAN_CPU)
9	PCI-e x16 Connector (SLOT1)	20	Memory Connectors (DIMM1, DIMM2, DIMM3, DIMM4)
10	PCI-e x1 Connector (SLOT2)	21	Power Switch Connector (PWR_SW)
11	PCI Connector (SLOT3)	22	P1 Power Connector (POWER)
		23	Front USB3.0 Connector (Front_USB)

SMALL FORM FACTOR COMPUTER (SFF) VIEW

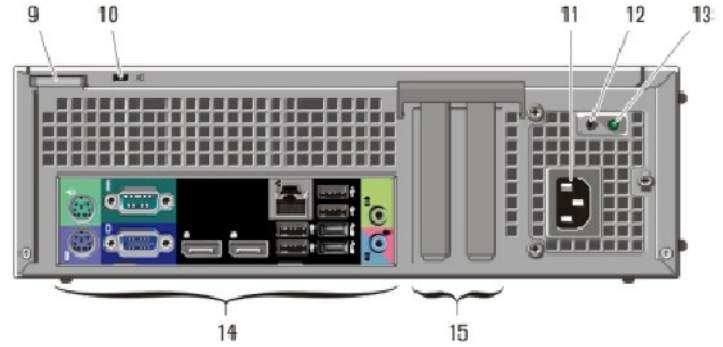
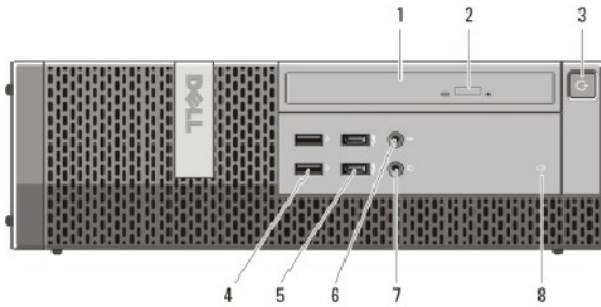

FRONT VIEW			
1	Optical Drive	5	USB 3.0 Connectors (2)
2	Optical Drive Eject Button	6	Microphone Connector
3	Power Button, Power Light	7	Headphone Connector
4	USB 2.0 Connectors (2)	8	Drive Activity Light

BACK VIEW			
9	Padlock Ring	13	Power Supply Diagnostic Light
10	Kensington / Noble Security Cable Slot	14	Back Panel Connectors
11	Power Connectors	15	Expansion Card Slots (2)
12	Power Supply Diagnostic Button		

BACK PANEL CONNECTORS			
1	PS2 Mouse Connector	7	PS2 Keyboard Connector
2	Serial Connector	8	VGA Connector
3	Link Integrity Light	9	DisplayPort Connector (2)
4	Network Connector	10	USB2.0 Connectors (2)
5	Network Activity Light	11	USB2.0 Connectors (2) USB3.0 Connectors (2)
6	Line-out Connector	12	Line-in/Microphone Connector

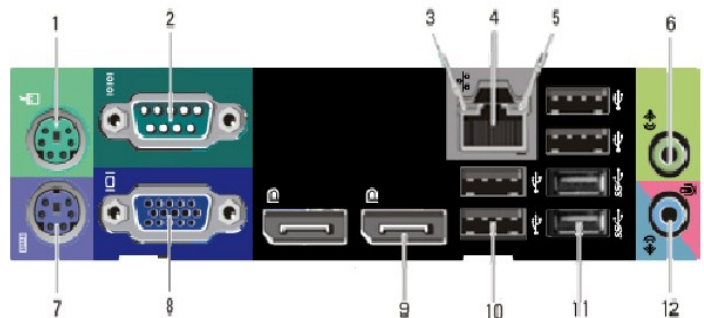

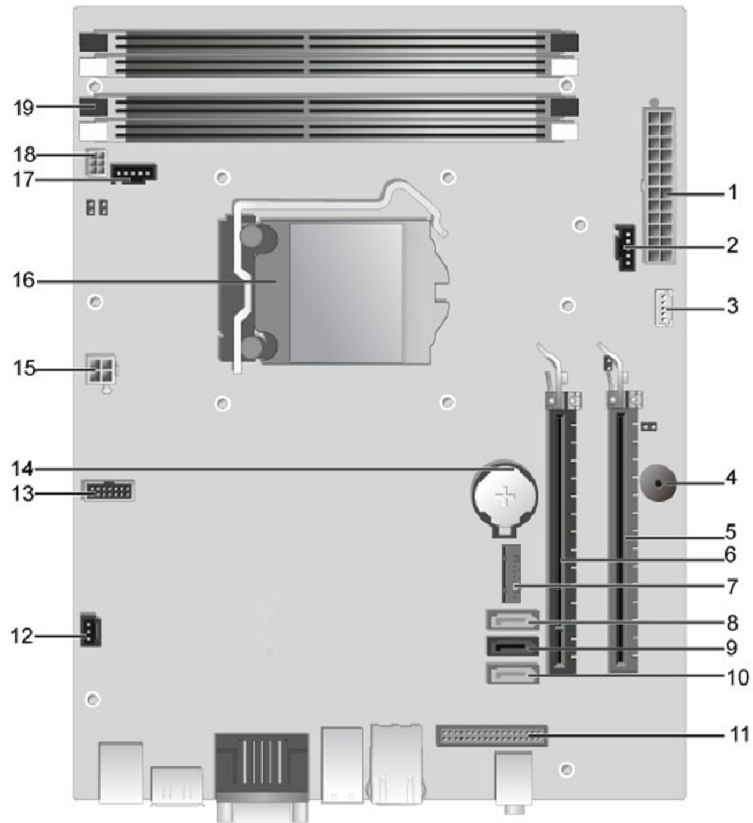

SFF System Board Components

Number	Name	Number	Name
1	P1 power Connector (POWER)	11	Front IO Connector (FRONTPANEL)
2	System fan Connector (FAN_HDD)	12	Intrusion Switch Connector (INTRUDER)
3	Internal Speaker Connector (INT_SPKR)	13	LPC debug Connector (LPC_DEBUG)
4	Buzzer (BEEP)	14	Battery Connector (BATTERY)
5	PCI-e x16 (wire x4) Connector (SLOT2)	15	P2 Power Connector (12V_PWRCONN)
6	PCI-e x16 Connector (SLOT1)	16	Processor Connector (N/A)
7	Front USB3.0 Connector (Front_USB)	17	CPU Fan Connector (FAN_CPU)
8	SATA 2 Connector (SATA2)	18	Power Switch Connector (PWR_SW)
9	SATA 1 Connector (SATA1)	19	Memory Connectors (DIMM1, DIMM2, DIMM3, DIMM4)
10	SATA 0 Connector (SATA0)		

ULTRA SMALL FORM FACTOR COMPUTER (USFF) VIEW

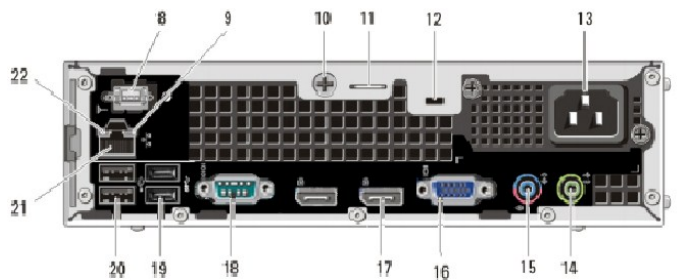
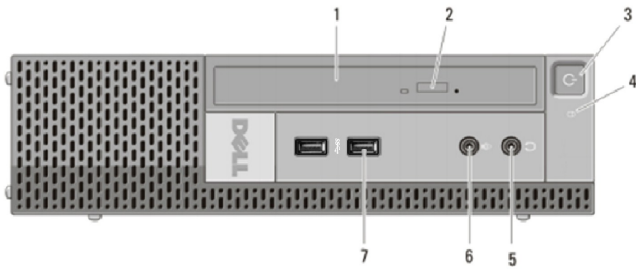

FRONT VIEW			
1	Optical Drive	5	Headphone Connector
2	Optical Drive Eject Button	6	Microphone Connector
3	Power Button, Power Light	7	USB 3.0 Connectors (2)
4	Drive Activity Light		

BACK VIEW			
8	Wi-Fi Antenna (optional)	15	Line-in/ Microphone Connector
9	Network Activity Light	16	VGA Connector
10	Captive Thumbscrew	17	DisplayPort Connector (2)
11	Padlock Ring	18	Serial Connector
12	Kensington / Noble Security Cable Slot	19	USB 3.0 Connectors (2)
13	Power Connector	20	USB 2.0 Connectors (2)
14	Line-Out Connector	21	Network Connector
		22	Link Integrity Light

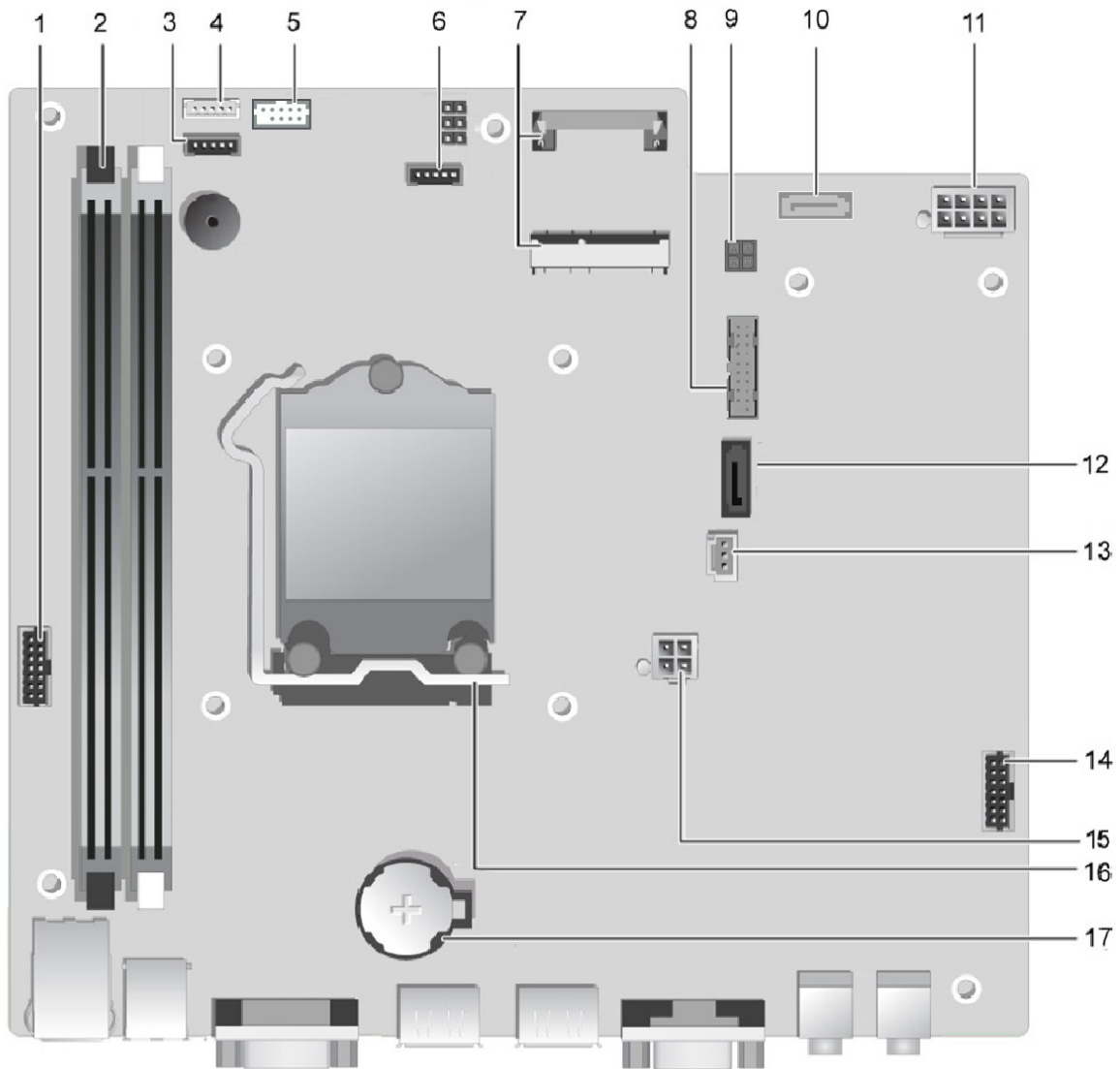

USFF System Board Components

Number	Name	Number	Name
1	Front Panel Connector (FRONTPANEL)	9	HDD-ODD Power Connector (HDD_ODD_POWER)
2	Memory Connector (DIMM_1, DIMM_2)	10	SATA 1 Connector (SATA1)
3	CPU Fan Connector (FAN_CPU)	11	P1 Power Connector (POWER)
4	Internal Speaker Connector (INT_SPKR)	12	SATA 0 Connector (SATA0)
5	Front IO Connector (F_USB_AUDIO)	13	Intrusion Switch Connector (INTRUDER)
6	System Fan Connector (FAN_HDD)	14	LPC Debug Connector (LPC_DEBUG)
7	Mini-PCI Socket (PCIE_MINICARD)	15	P2 Power Connector (12V_PWRCONN)
8	Front USB3.0 connector (Front USB)	16	Processor socket (N/A)
		17	Battery Connector (BATTERY)

MARKETING SYSTEM CONFIGURATIONS

NOTE: Offerings may vary by country. For more information regarding the configuration of your computer, click Start>Help and Support and select the option to view information about your computer.

OPERATING SYSTEM

	MT	DT	SFF	USFF
Windows Operating System	Microsoft® Windows 7® Home Basic SP1 (32 and 64 bit), Microsoft® Windows 7® Home Premium SP1 (32 and 64 bit), Microsoft® Windows 7® Home Premium w/MUI SP1 (32 and 64 bit), Microsoft® Windows 7® Professional w/MUI SP1 (32 and 64 bit), Microsoft® Windows 7® Professional SP1 (32 and 64 bit), Microsoft® Windows 7® Ultimate SP1 (32 and 64 bit),			
Other	Ubuntu (N-Series DIB) (32bit) Ubuntu (32bit)			
OS Media Support	Optional			

CHIPSET

	MT	DT	SFF	USFF
Chipset	Intel Q77 Express Chipset			
Non-volatile memory on chipset				
BIOS Configuration SPI (Serial Peripheral Interface)	64Mbit (8MB) & 32Mbit(4MB) located at SPI_FLASH on chipset			
TPM 1.2 Security Device (Trusted Platform Module) ¹	4KB located at TPM1.2 on chipset			
Non-TPM	Available in select countries			
NIC EEPROM	LOM configuration contained within SPI_FLASH – no dedicated LOM EEPROM			

PROCESSOR¹

NOTE: Global Standard Products (GSP) are a subset of Dell’s relationship products that are managed for availability and synchronized transitions on a worldwide basis. They ensure the same platform is available for purchase globally. This allows customers to reduce the number of configurations managed on a worldwide basis, thereby reducing their costs. They also enable companies to implement global IT standards by locking in specific product configurations worldwide. The following GSP processors identified below will be made available to Dell customers.

NOTE: Processor numbers are not a measure of performance. Processor availability subject to change and may vary by region/country.

	MT	DT	SFF	USFF
Intel® Quad Core Processors				
Intel® Core™ i7 3770 / 3.10GHz, 8M, VT-x, VT-d, TXT (vPro™), 77W	GSP	GSP	GSP	
Intel® Core™ i7 3770S / 3.40GHz, 8M, VT-x, VT-d, TXT (vPro™), 65W				GSP
Intel® Core™ i5 3570 / 3.40GHz, 6M, VT-x, VT-d, TXT (vPro™), 77W ²	GSP	GSP	GSP	
Intel® Core™ i5 3570S / 3.10GHz, 6M, VT-x, VT-d, TXT (vPro™), 65W ²				GSP
Intel® Core™ i5 3470 / 3.20GHz, 6M, VT-x, VT-d, TXT (vPro™), 77W ²	GSP	GSP	GSP	
Intel® Core™ i5 3475S / 2.90GHz, 6M, VT-x, VT-d, TXT (vPro™), 65W ²	GSP	GSP	GSP	GSP
Intel® Core™ i5 3470S / 2.90GHz, 6M, VT-x, VT-d, TXT (vPro™), 65W ²				GSP
Intel® Core™ i5 3550 / 3.30GHz, 6M, VT-x, VT-d, TXT (vPro™), 77W ³	X	X	X	
Intel® Core™ i5 3550S / 3.00GHz, 6M, VT-x, VT-d, TXT (vPro™), 65W ³				X
Intel® Core™ i5 3450 / 3.10GHz, 6M, 77W ³	X	X	X	
Intel® Core™ i5 3450S / 2.80GHz, 6M, 65W ³				X
Intel® Dual Core Processors				
Intel® Core™ i3 2130 / 3.40GHz, 3M, VT-x, 65W	X	X	X	X
Intel® Core™ i3 2125 / 3.30GHz, 3M, VT-x, 65W	X	X	X	X
Intel® Core™ i3 2120 / 3.30GHz, 3M, VT-x, 65W	X	X	X	X
Intel® Core™ G860 / 3.0GHz, 3M, VT-x, 65W ²	X	X	X	X
Intel® Core™ G850 / 2.9GHz, 3M, VT-x, 65W ³	X	X	X	X
Intel® Core™ G640 / 2.8GHz, 3M, VT-x, 65W ²	X	X	X	X
Intel® Core™ G630 / 2.7GHz, 3M, VT-x, 65W ³	X	X	X	X

¹ 3rd generation CPUs natively support 3 displays with the integrated CPU graphics. Three simultaneous display output requires one DP port with a maximum resolution of 2500x1600 at 60Hz refresh rate and a DP and VGA port with max resolutions of 1920x1200 at 60Hz refresh rates.

² Post launch CPU, available from June for G860; July for G640, i5 3470/S, i5 3570/S, i5 3475S.

³ Available at launch, will be replaced in June or July, i5 3470/S replace i5 3450/S; i5 3570/S replace i5 3550/S; G860 replace G850; G640 replace G630.

MEMORY

NOTE: Memory modules should be installed in pairs of matched memory size, speed, and technology. If the memory modules are not installed in matched pairs, the computer will continue to operate, but with a slight reduction in performance. The entire memory range is available to 64-bit operating systems.

	MT	DT	SFF	USFF
Type: DDR3 Synch DRAM Non-ECC Memory	1600MHz ²			
DIMM Slots	4	4	4	2
DIMM Capacities	Up to 8GB	Up to 8GB	Up to 8GB	Up to 8GB
Minimum Memory	2GB	2GB	2GB	2GB
Maximum System Memory	32GB ¹	32GB ¹	32GB ¹	16GB ¹
Memory configurations				
32GB ¹ DDR3, 1600MHz ² , (4 x 8GB)	X	X	X	
16GB ¹ DDR3, 1600MHz ² , (4 x 4GB)	X	X	X	
16GB ¹ DDR3, 1600MHz ² , (2 x 8 GB)				X
8GB ¹ DDR3, 1600 MHz ² , (2 x 4GB)	X	X	X	X
6GB ¹ DDR3, 1600MHz ² , (2GB + 4GB)	X	X	X	X
4GB ¹ DDR3, 1600MHz ² , (2 x 2GB)	X	X	X	X
4GB ¹ DDR3, 1600MHz ² , (1 DIMM)	X	X	X	X
2GB DDR3, 1600MHz ² , (1 DIMM)	X	X	X	X

¹To fully utilize 4GB or more of memory requires a 64-bit enabled processor and 64-bit operating system. With 32-bit OS, the total amount of available memory will be less than 4GB. The amount less depends on the actual system configuration.

²1600MHz memory will only perform as 1600MHz memory when 3rd generation CPUs are used. It will perform as 1333MHz memory if 2nd generation i3 2130, i3 2125, i3 2120, G860, G850 CPUs are installed in the system. It will perform as 1066MHz memory if 2nd generation G640, G630 CPUs are installed in the system.

DRIVES AND REMOVABLE STORAGE

	MT	DT	SFF	USFF
Bays:				
5.25-inch Optical Bay Supported (External)	2	1	1	1
Optical Drives Supported (maximum)	2	1	1 (slim-line)	1 (slim-line)
Hard Drive Bay Supported (Internal)	2	1	1	1
Hard Drives Supported 3.5"/2.5" (maximum)	2/2	1/2	1/2	0/1
Interface:				
SATA 2.0	2	1	1	0
SATA 3.0	2	2	2	2
3.5" Hard Drives:				
1TB ¹ SATA 7200 RPM HDD	X	X	X	
500GB ¹ SATA 7200 RPM HDD	X	X	X	
250GB ¹ SATA 7200 RPM HDD	X	X	X	
2.5" Hard Drives:				
500GB ¹ SATA 7200 RPM HDD	X	X	X	X
320GB ¹ SATA 7200 RPM HDD	X	X	X	X
320GB ¹ SATA 7200 RPM OPAL SED w/FIPS HDD	X	X	X	X
500GB ¹ SATA 7200 RPM Hybrid HDD	X	X	X	X
128GB ¹ SATA Solid State drive	X	X	X	X
RAID 1 Data Protection: (includes two matching capacity/speed hard drives)				
1TB ¹ SATA 7200 RPM HDD (3.5")	X			
500GB ¹ SATA 7200 RPM HDD (3.5")	X			
250GB ¹ SATA 7200 RPM HDD (3.5")	X			
500GB ¹ SATA 7200 RPM HDD (2.5")	X	X	X	
320GB ¹ SATA 7200 RPM HDD (2.5")	X	X	X	
500GB ¹ SATA 7200 RPM Hybrid HDD (2.5")	X	X	X	

¹ For hard drives, GB means 1 billion bytes; actual capacity varies with preloaded material and operating environment and will be less.

DRIVES AND REMOVABLE STORAGE

	MT	DT	SFF	USFF
RAID 0 Performance: (includes two matching capacity/speed hard drives)				
1TB ¹ SATA 7200 RPM HDD (3.5")	X			
500GB ¹ SATA 7200 RPM HDD (3.5")	X			
250GB ¹ SATA 7200 RPM HDD (3.5")	X			
500GB ¹ SATA 7200 RPM HDD (2.5")	X	X	X	
320GB ¹ SATA 7200 RPM HDD (2.5")	X	X	X	
500GB ¹ SATA 7200 RPM Hybrid HDD (2.5")	X	X	X	
Optical Drive: (SFF/USFF require slim-line optical drive)				
Blu-ray Writer SATA	X	X	X	X
DVD+/-RW ² SATA	X	X	X	X
DVD-ROM ³ SATA	X	X	X	X
Media Card Reader:				
Dell 19 in 1 Media Card Reader ⁴	X	X		

¹ For hard drives, GB means 1 billion bytes; actual capacity varies with preloaded material and operating environment and will be less.

² Discs burned with this drive may not be compatible with some existing drives and players; using DVD+R media provides maximum compatibility.

³ DVD-ROM drives may have write-capable hardware that has been disabled via firmware modifications.

⁴ Dell 19 in 1 Media Card Reader (MCR) is supported via a F5 to F3 bay converter on the MT and DT and requires a slim line optical drive.

SYSTEM BOARD CONNECTORS

NOTE: See Detailed Engineering Specifications for maximum card dimensions.

	MT	DT	SFF	USFF
PCI Slot(s) ¹	1	1		
PCIe x16 Slot(s) ²	1	1	1	
PCIe x16 (wired x4) Slot(s) ³	1	1	1	
PCIe x1 Slot(s) ³	1	1		
miniPCIe connector (s) ³				1
Serial ATA (SATA) ⁴	4	3	3	2

¹ PCI Slots (Support Standard Rev 2.3)

² PCIe x16 Slots (Support Standard Rev 3.0)

³ PCIe x16 (wired x 4), PCIe x1 Slots, miniPCIe (Support Standard Rev 2.0)

⁴ Serial ATA (2 ports Support Standard Rev 3.0, the rest of ports Support Standard Rev 2.0)

GRAPHICS/VIDEO CONTROLLER

NOTE: MT supports full height (FH) cards and DT and SFF supports low profile (LP) cards.

	MT	DT	SFF	USFF
Integrated Intel® HD Graphics 2500/4000 (3 rd generation Core i3/i5/i7 CPUs); Integrated Intel® HD Graphics 2000/3000 (2 nd generation Core i3 CPUs); Integrated Intel® HD Graphics (Pentium® Dual Core CPU);	Integrated on CPU			
Enhanced Graphic/Video Options				
1GB AMD RADEON HD 7570	Optional card			
1GB AMD RADEON HD 7470	Optional card			
1GB NVIDIA GEFORCE™ GT640 ¹	Optional card			

¹GT640 available in June 2012

EXTERNAL PORTS/CONNECTORS

	MT	DT	SFF	USFF
USB 2.0 (Front/Rear/Internal)	2/4/2	2/4/2	2/4/0	0/2/0
USB 3.0 (Front/Rear/Internal)	2/2/0	2/2/0	2/2/0	2/2/0
Serial	1 Rear			
Network Connector (RJ-45)	1 Rear			
PS/2	2 Rear			
1394a Controller via optional PCI card	Optional FH card	Optional LP card		
Video:				
VGA	1 Rear			
DisplayPort	2 Rear			
Audio:				
Line in for microphone	1 Front			
Line in for microphone or stereo	1 Rear			
Line out for headphones or speakers	1 Front, 1 Rear			

COMMUNICATIONS - NETWORK ADAPTER (NIC)

NOTE: MT supports full height (FH) cards and DT and SFF supports low profile (LP) cards.

	MT	DT	SFF	USFF
Intel® 82579LM Gigabit ¹ Ethernet LAN 10/100/1000 (Remote Wake Up, PXE support and Intel Active Management Technology support)	Integrated on system board			
Broadcom NetXtreme 10/100/1000 PCIe Gigabit Networking Card	Optional card			

¹ This term does not connote an actual operating speed of 1 Gb/sec. For high speed transmission, connection to a Gigabit Ethernet server and network infrastructure is required.

COMMUNICATIONS – WIRELESS

NOTE: MT supports full height (FH) cards and DT and SFF supports low profile (LP) cards.

	MT	DT	SFF	USFF
Dell Wireless 1530 PCIe WLAN card (802.11n)	Optional card			
Dell Wireless 1530 half miniPCIe WLAN card (802.11n)				Optional

AUDIO AND SPEAKERS

	MT	DT	SFF	USFF
Realtek ALC269Q High Definition Audio Codec	Integrated on system board			
Dell AX210 USB Stereo speakers	Optional			
Dell AX510/AX510PA Flat Panel Soundbar Speakers	Optional			

KEYBOARD AND MOUSE

	MT	DT	SFF	USFF
Dell USB Entry Keyboard with optional palmrest	Optional			
Dell Multimedia Pro Keyboard	Optional			
Dell Smart Card Keyboard	Optional			
Dell USB Optical Mouse	Optional			
Dell Laser Mouse	Optional			

SECURITY

	MT	DT	SFF	USFF
Trusted Platform Module (TPM) 1.2 ¹	Integrated on system board			
Chassis Intrusion Switch	Optional			
Dell Smartcard Keyboard	Optional			
Chassis lock slot and loop support	Standard			
Dell Data Protection Hardware Encryption Engine	Optional			

¹TPM is not available in all countries. Depending on your country regulations, no-TPM system may be available.

SOFTWARE

	MT	DT	SFF	USFF
Dell Client Manager	Available via Dell.com			
Dell Data Protection Access (DDPA)	Standard			
Dell Data Protection Encryption (DDPE)	Optional			

ENVIRONMENTAL

NOTE: For more details on Dell Environmental features, please to go to Environmental Attributes section. See your specific region for availability.

	MT	DT	SFF	USFF
Sustainable packaging	X	X	X	
BFR/PVC—free limited configurations			Select countries only	
MultiPack packaging	Optional, US only			
Energy Efficient Power Supply	Optional			Standard

ALL-IN-ONE STANDS AND MOUNTS

	MT	DT	SFF	USFF
Small Form Factor AIO Stand			Optional	
Ultra Small Form Factor AIO Stand				Optional
Ultra Small Form Factor Wall Mount / Desk Mount				Optional

SERVICE AND SUPPORT

NOTE: For more details on Dell Service Plans please to go to: www.dell.com/service/service_plans

	MT	DT	SFF	USFF
3 Year Warranty ¹ Next Business Day On-site ² (3-3-3)	Standard			
ProSupport	Optional			

¹ For a copy of our guarantees or limited warranties, please write Dell USA L.P., Attn: Warranties, One Dell Way, Round Rock, TX 78682. For more information, visit www.dell.com/warranty.

² Service may be provided by third-party. Technician will be dispatched if necessary following phone-based troubleshooting. Subject to parts availability, geographical restrictions and terms of service contract. Service timing dependent upon time of day call placed to Dell. U.S. only.

DETAILED ENGINEERING SPECIFICATIONS

SYSTEM DIMENSIONS (PHYSICAL)

NOTE: System Weight and Shipping Weight is based on a typical configuration and may vary based on PC configuration. A typical configuration includes: integrated graphics, one hard drive, one optical drive.

	MT	DT	SFF	USFF
Chassis Volume (liters)	26.27	15.06	8.38	3.70
Chassis Weight (pounds/kilograms)	20.68 / 9.4	17.38 / 7.9	13.2 / 6.0	7.26 / 3.3
Chassis Dimensions: (HxWxD)				
Height (inches/centimeters)	14.17 / 36	14.17 / 36	11.42 / 29	9.32 / 23.67
Width (inches/centimeters)	6.89 / 17.5	4.02 / 10.2	3.65 / 9.26	2.56 / 6.5
Depth (inches/centimeters)	16.42 / 41.7	16.14 / 41	12.28/31.2	9.44 / 24
Shipping Weight (pounds/kilograms - includes packaging materials)	24.57 / 11.17	20.75 / 9.43	15.82/7.19	9.63 /4.375
Packaging Parameters (HxWxD)				
Height (inches/centimeters)	21.31/54.13	21.31 / 54.13	19.25/48.90	19.13/48.59
Width (inches/centimeters)	18.75/47.63	18.75/47.63	15.81/40.16	14.38/36.53
Depth (inches/centimeters)	14.09 / 35.79	10.84/27.53	10.19/25.88	9.63/24.46

SYSTEM BOARD CONNECTOR MAXIMUM ALLOWABLE DIMENSIONS

	MT	DT	SFF	USFF
PCI Slot (Voltage supported 3.3V/5V/12V/-12V)	1	1		
Height (inches/centimeters)	4.376 / 11.115	2.731 /6.89		
Length (inches/centimeters)	6.6 / 16.765	6.6/16.765		
Maximum Wattage	25W	25W		
PCIex16 Slot (BLUE) (Voltage supported 3.3V/12V)	1	1	1	
Height (inches/centimeters)	4.376 / 11.115	2.731 /6.89	2.731 /6.89	
Length (inches/centimeters)	6.6/ 16.765	6.6 /16.765	6.6 /16.765	
Maximum Wattage	75W	50W	50W	
PCIex16 wired as x4 Slot (BLACK) (Voltage supported 3.3/12V)	1	1	1	
Height (inches/centimeters)	4.376 / 11.115	2.731 /6.89	2.731 /6.89	
Length (inches/centimeters)	6.6 / 16.765	6.6 /16.765	6.6/16.765	
Maximum Wattage	25W	25W	25W	
PCIe x1 Slot (Voltage supported 3.3V/12V)	1	1		
Height (inches/centimeters)	4.376 / 11.115	2.731 / 6.89		
Length (inches/centimeters)	4.5 / 11.44	4.5 / 11.44		
Maximum Wattage	10W	10W		
Mini PCIe x1 Slot				1

SYSTEM LEVEL ENVIRONMENTAL AND OPERATING CONDITIONS

	MT	DT	SFF	USFF
Temperature				
Operating	10°C to 35°C (50°F to 95°F)			
Non-Operating (Storage)	-40°C to 65°C (-40°F to 149°F)			
Relative Humidity	20% to 80% (non-condensing)			
Maximum vibration				
Operating	0.25 G at 3 to 200 Hz at 0.5 octave/min			
Non-Operating	0.5 G at 3 to 200 Hz at 1 octave/min			
Maximum Shock				
Operating	Bottom half-sine pulse with a change in velocity of 50.8 cm/sec (20 inches/sec)			
Non-Operating	27-G faired square wave with a velocity change of 508 cm/sec (200 inches/sec)			
Maximum Altitude				
Operating	-15.2 to 3048 m (-50 to 10,000 ft)			
Non-Operating	-15.2 to 10,668 m (-50 to 35,000 ft)			

POWER

NOTE: These form factors utilize a more efficient Active Power Factor Correction (APFC) power supply. Dell recommends only Universal Power Supplies (UPS) based on Sine Wave output for APFC PSUs, not an approximation of a Sine Wave, Square Wave, or quasi-Square Wave. If you have questions, please contact the manufac-

	MT		DT		SFF		USFF
	APFC	EPA	APFC	EPA	APFC	EPA	EPA
Power Supply Wattage	275W	275W High Efficiency	250W	250W High Efficiency	240W	240W High Efficiency	200W High Efficiency
AC input Voltage Range	90 – 264Vac	90 – 264Vac	90 – 264Vac	90 – 264Vac	90 – 264Vac	90 – 264Vac	90 – 264Vac
AC input current (low ac range/high AC range)	5.0A / 2.5A	5.0A / 2.5A	4.4A / 2.2A	4.4A / 2.2A	4.0A / 2.0A	3.6A / 1.8A	2.9A / 1.45A
AC input Frequency	47HZ/63HZ	47HZ/63HZ	47HZ/63HZ	47HZ/63HZ	47HZ/63HZ	47HZ/63HZ	47 – 63 Hz
AC holdup time (80% load)	16 mini sec	16 mini sec	16 mini sec	16 mini sec	16 mini sec	16 mini sec	16 mini sec
Minimum Efficiency (Energy Star 5.2 Compliant)		87 – 90 – 87% @ 20 – 50 – 100% load		87 – 90 – 87% @ 20 – 50 – 100% load		87 – 90 – 87% @ 20 – 50 – 100% load	87 – 90 – 87% @ 20 – 50 – 100% load
Typical Efficiency (Active PFC)	65%		65%		65%		N/A
DC parameters							
+3.3V output	10.0A	10.0A	7.0 A	7.0 A	3.5A	3.5A	N/A
+5.0V output	13A	13A	15A	15A	11A	11A	N/A
+12.0V output	12VA/17A; 12VB/10A	12VA/17A; 12VB/10A	17.8A	17.8A	17A	17A	+12VA - 12.5 A & +12VB - 6.0 A Note: +12VB Rated at 0.4A when in Standby Mode.
+5.0V auxiliary output	4.0A	4.0A	4.0	4.0	4.0A	4.0A	N/A
-12.0V output	0.5A	0.5A	0.5A	0.5A	0.5A	0.5A	0.1 A
Max total power	275W	275W	250W	250W	240W	240W	200W
Max combined +3.3V / +5.0V power	100W	100W	90W	90W	60W	60W	N/A
Max combined 12.0V power (note: only if more than one 12V rail)	240W	240W	N/A	N/A	N/A	N/A	200W
BTUs/h (based on PSU max wattage)	938 BTU	938 BTU	853 BTU	853 BTU	819 BTU	819 BTU	682 BTU
Power Supply Fan	80*25mm	80*25mm	80*20/25mm	80*20/25mm	60*25mm	60*25mm	N/A
Compliance:							
Erp Lot6 Tier 2 0.5watt requirement	Yes	Yes	Yes	Yes	Yes	Yes	Yes
Blue Angel Compliant	Yes	Yes	Yes	Yes	Yes	Yes	Yes
Climate Savers / 80Plus Compliant	No	Yes	No	Yes	No	Yes	Yes
FEMP Standby Power Compliant	Yes	Yes	Yes	Yes	Yes	Yes	Yes
CECP Compliant	No	Yes	No	Yes	No	Yes	Yes

POWER

NOTE: These form factors utilize a more efficient Active Power Factor Correction (APFC) power supply. Dell recommends only Uninterruptible Power Supplies (UPS) based on Sine Wave output for APFC PSUs, not an approximation of a Sine Wave, Square Wave, or quasi-Square Wave. If you have questions, please contact the manufacture to confirm the output type.

3.0v CMOS battery (Type and estimated battery life)				
Brand	Type	Voltage	Composition	Life
PANASONIC	CR-2032L/BE	3V	Lithium	Continuous Discharge Under 15 kΩ Load to 2.5V End-Voltage. 20°C±2°C: 1183Hrs. or Longer, 1133Hrs.or Longer after 12 months.
MITSUBISHI	CR2032	3V	Lithium	Continuous Discharge Under 15 kΩ Load to 2.0V End-Voltage. 20°C ±2°C: 1000Hrs. or Longer, 970Hrs. or Longer after 12 months. 0°C ±2°C: 910Hrs. or Longer, 890Hrs. or Longer after 12 months.

AUDIO

INTEGRATED REALTEK ALC269Q HIGH DEFINITION AUDIO	MT	DT	SFF	USFF
High Definition Stereo support	X	X	X	X
Number of channels	2			
Number of Bits / Audio resolution	16, 20, and 24-bit resolution			
Sampling rate (recording/playback)	Support 44.1K/48K/96K/192 kHz sample rates			
Signal to Noise Ratio	98 dB DAC outputs, 90 dB for ADC inputs			
Analog Audio	X	X	X	X
Dolby Digital				
THX				
Digital out (S/PDIF)				
Audio Jack Impedance				
Microphone	40K ohm~60K ohm			
Line-In	40K ohm~60K ohm			
Line-Out	100~150 ohm			
Headphone	1~4 ohm			
Internal Speaker Power Rating	2Watt (peak) / 1Watt (average)			

COMMUNICATIONS - INTEGRATED LAN

INTEGRATED INTEL® 82579 GIGABIT¹ ETHERNET LAN 10/100/1000	MT	DT	SFF	USFF
External Connector Type	RJ45			
Data Rates supported	10/100/1000 Mbps			
Controller Details				
Controller bus architecture	PCIe-based interface for S0 state, SMBus for Sx low power state			
Integrated memory	N/A			
Data transfer mode (example Bus-Master DMA)	N/A			
Power consumption (full operation per data rate connection speed)	711mW (Max.)			
Power consumption (standby operation)	227mW (Max.)			
IEEE standards compliance (example 802.1P)	802.3			
Hardware Certifications (example FCC, B, GS mark...)	N/A			
Boot ROM Support	EEPROM (located in SPI)			
Network Transfer Mode (example Full Duplex, Half Duplex)				
Network Transfer Rate (example 10BASE-T (half-duplex) 10 Mbps 10BASE-T (full-duplex) 20 Mbps 100BASE-TX (half-duplex) 100 Mbps 100BASE-TX (full-duplex) 200 Mbps 1000BASE-T (full-duplex) 2000 Mbps)	10 Mb (full/half-duplex) 100 Mb (full/half-duplex) 1000 Mb (full-duplex)			

COMMUNICATIONS - INTEGRATED LAN (CON.)

INTEGRATED INTEL® 82579 GIGABIT ¹ ETHERNET LAN 10/100/1000 (CONT.)	MT	DT	SFF	USFF
Environmental				
Operating temperature	0° C to 85° C (32° F to 185° F)			
Operating humidity	20% to 80% (non-condensing)			
Operating System Driver Support	Microsoft Client XP/Vista/Win 7 (32bit/64bit)			
Manageability (examples WOL, PXE)	WOL, PXE 2.1			
Management Capabilities Alerting	Intel® Standard Manageability, 3rd generation i5/i7 processors with vPro Technology			

¹ This term does not connote an actual operating speed of 1 Gb/sec. For high speed transmission, connection to a Gigabit Ethernet server and network infrastructure is required.

COMMUNICATIONS – NETWORK ADAPTER (NIC)

NOTE: MT supports full height (FH) cards and DT and SFF supports low profile (LP) cards.

BROADCOM NETXTREME 10/100/1000 PCIE GIGABIT ¹ NETWORKING CARD	MT	DT	SFF	USFF
Connector Type	RJ45			
Data Rates supported	10/100/1000 Mbps Half/Full duplex			
Controller Details				
Controller bus architecture (example PCIe 1.0a x1)	PCIe c1.0a x1			
Integrated memory	64KBytes RX, 8KBytes TX			
Data transfer mode (example Bus-Master DMA)	Bus-Master DMA			
Power consumption (full operation per data rate connection speed)	2.84W (860mA @ +3.3V)			
Power consumption (standby operation)	Less than 300mW			
IEEE standards compliance (example 802.1P)	802.3, 802.2, 802.3x, 802.1p			
Hardware Certifications (example FCC, B, GS mark...)	FCC B, VCCI B, CE			
Boot ROM Support	No			
Network Transfer Mode (example Full Duplex, Half Duplex)				
Network Transfer Rate (example 10BASE-T (half-duplex) 10 Mbps 10BASE-T (full-duplex) 20 Mbps 100BASE-TX (half-duplex) 100 Mbps 100BASE-TX (full-duplex) 200 Mbps 1000BASE-T (full-duplex) 2000 Mbps)	10BASE-T (full-duplex) 20 Mbps Max* 100BASE-TX (half-duplex) 100 Mbps Max* 100BASE-TX (full-duplex) 200 MbpsMax* 1000BASE-T (full-duplex) 2000 Mbps Max* * Depends on the system environment.			

¹ This term does not connote an actual operating speed of 1 Gb/sec. For high speed transmission, connection to a Gigabit Ethernet server and

COMMUNICATIONS – NETWORK ADAPTER (NIC) (CONT.)

**BROADCOM NETXTREME 10/100/1000
PCI-E GIGABIT¹ NETWORKING CARD (CONT.)**

	MT	DT	SFF	USFF
Environmental				
Operating temperature	0°C to 55°C (32°F - 131°F)			
Operating humidity	5% ~ 85% (non-condensing)			
Operating System Driver Support	Microsoft Client XP/Vista/Win 7 (32bit/64bit) Linux			
Manageability (examples WOL, PXE)	WOL, PXE2.1, ACPI			
Management Capabilities Alerting (example ASF 2.0)	None			

¹ This term does not connote an actual operating speed of 1 Gb/sec. For high speed transmission, connection to a Gigabit Ethernet server and network infrastructure is required.

1394a FIREWIRE PCI ADD-IN CARD	
Connector Type	IEEE-1394a-2000 (6 pins)
Controller Details	
Controller bus architecture (example PCIe 1.0a x1)	PCI 2.3
Chipset	LSI
IO Ports	IEEE 1394a (FireWire) with a transfer rate of up to 400Mbps
Power Consumption	Under 30 mA
Connector	2 IEEE-1394a 6 pins connectors
OS Support	Win XP (32bit/64bit), Win Vista (32bit/64bit) and Win 7 (32bit/64bit)

COMMUNICATIONS – WIRELESS

DELL WIRELESS 1530 PCIE WLAN CARD (802.11N)	MT	DT	SFF	USFF
Dell Wireless 1530 PCIe WLAN card (802.11n)	Integrated Antenna			
Dell Wireless 1530 half miniPCIe WLAN card (802.11n)				Custom WLAN Antenna
Controller Details				
Controller bus architecture	Electrically compatible with the PCI Express Base Specification v1.1 (x1 lane) and PCIe v1.0a.			
WLAN standards supported	802.11a, 802.11b, 802.11g, 802.11n			
802.11b Data Rates supported	11, 5.5, 2, 1 Mbps			
802.11a Data Rates supported	54, 48, 36, 24, 18, 12, 9, 6 Mbps			
802.11g Data Rates supported	54, 48, 36, 24, 18, 12, 11, 9, 6, 5.5, 2, 1 Mbps			
802.11n Data Rates supported	270, 240, 180, 135, 130, 121.5, 120, 117, 108, 104, 90, 81, 78, 65, 60, 58.5, 54, 52, 40.5, 39, 30, 27, 26, 19.5, 13.5, 13, 6.5 Mbps			
Encryption	WEP 64-bit and 128-bit, TKIP, AES-CCMP 128-bit			
Operating temperature	0°C –70°C			
Operating humidity	Max Operating Humidity 85%			
Operating System Driver Support	Microsoft Client XP/Vista/Win 7 (32bit/64bit)			

COMMUNICATIONS – SERIAL / PARALLEL PORT PCIE ADD-IN CARD

NOTE: MT supports full height (FH) cards and DT and SFF supports low profile (LP) cards.

SERIAL / PARALLEL PORT PCIE ADD-IN CARD	MT	DT	SFF	USFF
Connector Type	RS-232 and IEEE1284			
Data Rates supported	50bps ~115.2Kbps (Serial) &Maximum 1.8MBp(Parallel)			
Controller Details				
Controller bus architecture (example PCIe 1.0a x1)	PCI Express one lane (x1)			
Driver Support	Microsoft Client XP/Vista/ Win 7 (32bit/64bit) Linux DOS			
Full height Serial / Parallel add-in card	Optional			
Environment				
Operation Temperature	0°C to 60°C (32°F to 140°F)			
Operation Humidity	5 to 95% RH			
Storage Temperature	-20°C to 85°C (-4°F to 185°F)			

COMMUNICATIONS – SERIAL PORT PCIE ADD-IN CARD

NOTE: MT supports full height (FH) cards and DT and SFF supports low profile (LP) cards.

SERIAL PORT PCIE ADD-IN CARD	MT	DT	SFF	USFF
Connector Type	RS-232			
Data Rates supported	50bps ~115.2Kbps			
Controller Details				
Controller bus architecture (example PCIe 1.0a x1)	PCI Express one lane (x1)			
Driver Support	Microsoft Client XP/Vista/Win 7 (32bit/64bit) Linux DOS			
Half height Serial add-in card		Optional		
Environment				
Operation Temperature	0°C to 60°C (32°F to 140°F)			
Operation Humidity	5 to 95% RH			
Storage Temperature	-20°C to 85°C (-4°F to 185°F)			

COMMUNICATIONS – SERIAL / PARALLEL PORT PCIE ADD-IN CARD

NOTE: MT supports full height (FH) cards and DT and SFF supports low profile (LP) cards.

PARALLEL PORT PCIE ADD-IN CARD	MT	DT	SFF	USFF
Connector Type	IEEE1284			
Data Rates supported	Maximum 1.8MBp			
Controller Details				
Controller bus architecture (example PCIe 1.0a x1)	PCI Express one lane (x1)			
Driver Support	Microsoft Client XP/Vista/7 (32bit/64bit) Linux DOS			
Half height parallel add-in card		Optional		
Environment				
Operation Temperature	0°C to 60°C (32°F to 140°F)			
Operation Humidity	5 to 95% RH			
Storage Temperature	-20°C to 85°C (-4°F to 185°F)			

GRAPHICS/VIDEO CONTROLLER

NOTE: MT supports full height (FH) cards and DT and SFF supports low profile (LP) cards.

Onboard Graphics^{1,2,3,4}
 Integrated Intel® HD Graphics 2500/4000 (3rd generation Core i3/i5/i7 CPUs);
 Integrated Intel® HD Graphics 2000/3000 (2nd generation Core i3 CPUs);
 Integrated Intel® HD Graphics (Pentium® Dual Core CPU);

	MT	DT	SFF	USFF
Bus Type	Integrated			
GPU core clock	Gen6 Core Intel® HD Graphics /HD Graphics 2000 @ 850MHz Gen7 Core Intel® HD Graphics 2500 / 4000 @ 650MHz			
Frame Buffer Memory (onboard and shared) Size and Speed	Depends on available system memory (Up to 1.7GB with 4GB system Memory)			
Overlay Planes	Yes			
Maximum Color Depth	32 bit			
Maximum Vertical Refresh Rate	75 Hz			
Multiple Display Support	Yes			
Operating Systems Graphics/ Video API Support	OpenGL 3.1/OpenCLv1.1 /DirectX 11			
Supported Resolutions and Max Refresh Rates (Hz) (Note: Analog and/or digital)	Up to 2560x1600 @ 60Hz (DP) Up to 1920 x 1200 @ 60 Hz (VGA only)			
External Connectors	VGA, 2 DisplayPort			
DisplayPort		DisplayPort		
Bus Type	DDPC			
DisplayPort Audio Support	Yes			
VGA				
Bus Type	CRT			
VGA Audio Support	No			

¹ Up to 1.7 GB of system memory may be allocated to support integrated graphics, depending on operating system, system memory size and other factors.

² 3rd generation CPUs natively support 3 displays with the integrated CPU graphics. Three simultaneous display output requires one DP port with a maximum resolution of 2500x1600 at 60Hz refresh rate and a DP and VGA port with max resolutions of 1920x1200 at 60Hz refresh rates.

³ Display output from both onboard and discrete simultaneously if multi display option in BIOS is enabled and Win 7 OS is used.

⁴ For dual graphics card configuration in PCIe16 and PCIe16 (wire as 4), BIOS will disable multi display option automatically and display output only from graphics cards.

1GB NVIDIA GEFORCE™ GT640	MT	DT	SFF
Bus Type (example integrated or PCIe x16)	PCIEx16		
GPU core clock	950Mhz		
Frame Buffer Memory (onboard and shared) Size and Speed	1250Mhz		
Maximum power consumption	75W		
Overlay Planes	Yes		
Maximum Color Depth	32bit		
Maximum Vertical Refresh Rate	240Hz		
Multiple Display Support	Yes		
Operating Systems Graphics/ Video API Support	D3D/OpenGL 3.1/OpenCLv1.1/DirectX11		
Supported Resolutions and Max Refresh Rates (Hz) (Note: Analog and/or digital)	Dual-Link DVI: 2560 x 1600, 32-bit color DisplayPort: 2560 x 1600, 32-bit color HDMI: 1920 x 1440, 32-bits color		
External connectors	DisplayPort, DVI-I, HDMI		
Dimensions of full height card inches/centimeters (L x H)	6.6 x 4.7 / 16.764 x 12.0		
Dimensions of low profile card inches/centimeters (L x H)		NA	
Environmental Operating Conditions (Non-Condensing):			
Operating Temperature Range	10°C -50°C		
Relative Humidity Range	5-90% RH		
Altitude Range	0-20,000 ft.		

1GB AMD RADEON™ HD7570

	MT	DT	SFF
Bus Type (example integrated or PCIe x16)	PCIEx16		
GPU core clock	650Mhz		
Frame Buffer Memory (onboard and shared) Size and Speed	800Mhz		
Maximum power consumption	50W		
Overlay Planes	Yes		
Maximum Color Depth	32-bit		
Maximum Vertical Refresh Rate	200Hz		
Multiple Display Support	Yes		
Operating Systems Graphics/ Video API Support	D3D/OpenGL 3.1/OpenCLv1.1/DirectX11		
Supported Resolutions and Max Refresh Rates (Hz) (Note: Analog and/or digital)	Dual-Link DVI: 2560 x 1600, 32-bit color DisplayPort: 2560 x 1600, 32-bit color		
External connectors	DisplayPort, DVI-I		
Dimensions of full height card inches/centimeters (L x H)	6.6 x 4.7 / 16.764 x 12.0		
Dimensions of low profile card inches/centimeters (L x H)		6.6 x 3.35 / 16.764 x 8.5	
Environmental Operating Conditions (Non-Condensing):			
Operating Temperature Range	10°C -55°C		
Relative Humidity Range	5-90% RH		
Altitude Range	0-20,000 ft.		

1GB AMD RADEON™ HD7470

	MT	DT	SFF
Bus Type (example integrated or PCIe x16)	PCIEx16		
GPU core clock	775Mhz		
Frame Buffer Memory (onboard and shared) Size and Speed	900Mhz		
Maximum power consumption	25W		
Overlay Planes	Yes		
Maximum Color Depth	32-bit		
Maximum Vertical Refresh Rate	200Hz		
Multiple Display Support	Yes		
Operating Systems Graphics/ Video API Support	D3D/OpenGL 3.1/OpenCLv1.1/DirectX11		
Supported Resolutions and Max Refresh Rates (Hz) (Note: Analog and/or digital)	Dual-Link DVI: 2560 x 1600, 32-bit color DisplayPort: 2560 x 1600, 32-bit color		
External connectors	DisplayPort, DVI-I		
Dimensions of full height card inches/centimeters (L x H)	6.6 x 4.7 / 16.764 x 12.0		
Dimensions of low profile card inches/centimeters (L x H)		6.6 x 3.35 / 16.764 x 8.5	
Environmental Operating Conditions (Non-Condensing):			
Operating Temperature Range	10°C -55°C		
Relative Humidity Range	5-90% RH		
Altitude Range	0-20,000 ft.		

HARD DRIVES¹

3.5" 1TB SATA 7200 RPM HDD	
Capacity	1TB
Dimensions inches (W x D x H)	Approximately (4.00 x 5.787 x 1.028 inches)
Interface type and Maximum speed	Up to 6Gb/s (SATA 3.0)
Internal buffer size	32 MB
Rotational Speed	7200 rpm
Logical Blocks	1,953,525,168
Power Source	
Power Consumption (reference only)	Idle 5.0W, Active 10.0W(running IOmeter utility)
Spin Up Current (reference only)	5V (1A) ,12V (2A)
Environmental Operating Conditions (Non-Condensing):	
Temperature Range	5°C to 60°C
Relative Humidity Range	20% to 80% non-condensing
Maximum Wet Bulb Temperature	29°C
Altitude Range	-50 ft to 10000 ft
Environmental Non-Operating Conditions (Non-Condensing):	
Temperature Range	-40°C to 65°C
Relative Humidity Range	10% to 90% non-condensing
Maximum Wet Bulb Temperature	38°C
Altitude Range	-50 ft to 35000 ft

¹ For hard drives, GB means 1 billion bytes ; actual capacity varies with preloaded material and operating environment and will be less.

HARD DRIVES¹ (CONT.)

3.5" 500GB SATA 7200 RPM HDD	
Capacity	500GB
Dimensions inches (W x D x H)	Approximately (4.00 x 5.787 x 1.028 inches)
Interface type and Maximum speed	Up to 6Gb/s (SATA 3.0)
Internal buffer size	16 MB
Rotational Speed	7200 rpm
Logical Blocks	976,773,168
Power Source	
Power Consumption (reference only)	Idle 5.0W, Active 10.0W(running IOmeter utility)
Spin Up Current (reference only)	5V (1A) ,12V (2A)
Environmental Operating Conditions (Non-Condensing):	
Temperature Range	5°C to 60°C
Relative Humidity Range	20% to 80% non-condensing
Maximum Wet Bulb Temperature	29°C
Altitude Range	-50 ft to 10000 ft
Environmental Non-Operating Conditions (Non-Condensing):	
Temperature Range	-40°C to 65°C
Relative Humidity Range	10% to 90% non-condensing
Maximum Wet Bulb Temperature	38°C
Altitude Range	-50 ft to 35000 ft

¹ For hard drives, GB means 1 billion bytes ; actual capacity varies with preloaded material and operating environment and will be less.

HARD DRIVES¹ (CONT.)

3.5" 250GB SATA 7200 RPM HDD	
Capacity	250GB
Dimensions inches (W x D x H)	Approximately (4.00 x 5.787 x 1.028 inches)
Interface type and Maximum speed	Up to 6Gb/s (SATA 3.0)
Internal buffer size	8 MB
Rotational Speed	7200 rpm
Logical Blocks	488,397,168
Power Source	
Power Consumption (reference only)	Idle 5.0W, Active 10.0W(running IOmeter utility)
Spin Up Current (reference only)	5V (1A) ,12V (2A)

Environmental Operating Conditions (Non-Condensing):	
Temperature Range	5°C to 60°C
Relative Humidity Range	20% to 80% non-condensing
Maximum Wet Bulb Temperature	29°C
Altitude Range	-50 ft to 10000 ft
Environmental Non-Operating Conditions (Non-Condensing):	
Temperature Range	-40°C to 65°C
Relative Humidity Range	10% to 90% non-condensing
Maximum Wet Bulb Temperature	38°C
Altitude Range	-50 ft to 35000 ft

¹ For hard drives, GB means 1 billion bytes ; actual capacity varies with preloaded material and operating environment and will be less.

HARD DRIVES¹ (CONT.)

2.5" 500GB SATA 7200 RPM HDD	
Capacity	500GB
Dimensions inches (W x D x H)	Approximately (3.93 x 2.75 x 0.374 inches)
Interface type and Maximum speed	Up to 3Gb/s
Internal buffer size	16 MB
Rotational Speed	7200 rpm
Logical Blocks	976,773,168
Power Source	
Power Consumption (reference only)	Idle 0.7W, Active 3.25W
Spin Up Current (reference only)	5V (1A)
Environmental Operating Conditions (Non-Condensing):	
Temperature Range	5°C to 60°C
Relative Humidity Range	20% to 80% non-condensing
Maximum Wet Bulb Temperature	29°C
Altitude Range	-50 ft to 10000 ft
Environmental Non-Operating Conditions (Non-Condensing):	
Temperature Range	-40°C to 65°C
Relative Humidity Range	10% to 90% non-condensing
Maximum Wet Bulb Temperature	38°C
Altitude Range	-50 ft to 35000 ft

¹ For hard drives, GB means 1 billion bytes ; actual capacity varies with preloaded material and operating environment and will be less.

HARD DRIVES¹ (CONT.)

2.5" 320GB SATA 7200 RPM HDD	
Capacity	320GB
Dimensions inches (W x D x H)	Approximately (3.93 x 2.75 x 0.374 inches)
Interface type and Maximum speed	Up to 3Gb/s
Internal buffer size	16 MB
Rotational Speed	7200 rpm
Logical Blocks	625, 142,448
Power Source	
Power Consumption (reference only)	Idle 0.7W, Active 3.25W
Spin Up Current (reference only)	5V (1A)
Environmental Operating Conditions (Non-Condensing):	
Temperature Range	5°C to 60°C
Relative Humidity Range	10% to 90% non-condensing
Maximum Wet Bulb Temperature	29°C
Altitude Range	-50 ft to 10000 ft
Environmental Non-Operating Conditions (Non-Condensing):	
Temperature Range	-40°C to 65°C
Relative Humidity Range	10% to 90% non-condensing
Maximum Wet Bulb Temperature	38°C
Altitude Range	-50 ft to 35000 ft

¹ For hard drives, GB means 1 billion bytes ; actual capacity varies with preloaded material and operating environment and will be less.

HARD DRIVES¹ (CONT.)

2.5" 320GB SATA 7200 RPM OPAL SED W/FIPS HDD	
Capacity	320GB
Dimensions inches (W x D x H)	Approximately (2.75 x 3.94 x 0.374 inches)
Interface type and Maximum speed	Up to 3Gb/s
Internal buffer size	16 MB
Rotational Speed	7200 rpm
Logical Blocks	625,142,448
Power Source	
Power Consumption (reference only)	Idle 0.7W, Active 3.25W
Spin Up Current (reference only)	5V (1A)
Environmental Operating Conditions (Non-Condensing):	
Temperature Range	5°C to 60°C
Relative Humidity Range	20% to 80% non-condensing
Maximum Wet Bulb Temperature	29°C
Altitude Range	-50 ft to 10000 ft
Environmental Non-Operating Conditions (Non-Condensing):	
Temperature Range	-40°C to 65°C
Relative Humidity Range	10% to 90% non-condensing
Maximum Wet Bulb Temperature	38°C
Altitude Range	-50 ft to 35000 ft

¹ For hard drives, GB means 1 billion bytes ; actual capacity varies with preloaded material and operating environment and will be less.

HARD DRIVES¹ (CONT.)

2.5" 500GB SATA 7200 RPM HYBRID HDD	
Capacity	500GB
Dimensions inches (W x D x H)	Approximately (3.93 x 2.75 x 0.374 inches)
Interface type and Maximum speed	Up to 6Gb/s
Internal buffer size	16 MB
Flash Cache	8GB
Logical Blocks	976,773,168
Power Source	
Power Consumption (reference only)	Idle 0.8W, Active 3.25W
Spin Up Current (reference only)	5V (1A)
Environmental Operating Conditions (Non-Condensing):	
Temperature Range	5°C to 60°C
Relative Humidity Range	20% to 80% non-condensing
Maximum Wet Bulb Temperature	29°C
Altitude Range	-50 ft to 10000 ft
Environmental Non-Operating Conditions (Non-Condensing):	
Temperature Range	-40°C to 65°C
Relative Humidity Range	10% to 90% non-condensing
Maximum Wet Bulb Temperature	38°C
Altitude Range	-50 ft to 35000 ft

¹ For hard drives, GB means 1 billion bytes ; actual capacity varies with preloaded material and operating environment and will be less.

HARD DRIVES¹ (CONT.)

2.5" 128GB¹ SATA SOLID STATE DRIVE	
Capacity	128GB
Dimensions inches (W x D x H)	Approximately (2.75 x 3.94 x 0.276 inches)
Interface type and Maximum speed	Up to 6Gb/s (SATA 3.0)
MTBF	1M hours
Logical Blocks	250,069,680
Power Source	
Power Consumption (reference only)	Idle 0.5W, Active 2.5W

Environmental Operating Conditions (Non-Condensing):	
Temperature Range	0°C to 70°C
Relative Humidity Range	10 to 90%
Maximum Wet Bulb Temperature	29°C
Op Shock (@0.5ms)	1,500G
Environmental Non-Operating Conditions (Non-Condensing):	
Temperature Range	-55°C to 95°C
Relative Humidity Range	5 to 95%
Maximum Wet Bulb Temperature	38°C

¹ For hard drives, GB means 1 billion bytes ; actual capacity varies with preloaded material and operating environment and will be less.

OPTICAL DRIVES

BLU-RAY WRITER	MT	DT	SFF	USFF
External Dimensions inches/centimeters (Without Bezel – W x H x D)	148.2mm(6in)/42mm (2in)/ 171 (max)	148.2mm(6in)/42mm (2in)/ 171 (max)	128.0 mm (5.04in)/ 12.7mm (0.5 in)/ 126.1mm (4.97in)	128.0 mm (5.04in)/ 12.7mm (0.5 in)/ 126.1mm (4.97in)
Weight (max) pounds/ kilograms	730g	730g	190g	190g
Interface type and speed	SATA 1.5Gbit/s	SATA 1.5Gbit/s	SATA 1.5Gbit/s	SATA 1.5Gbit/s
Disc Capacity	Standard	Standard	Standard	Standard
Internal buffer size	supplier dependent	supplier dependent	supplier dependent	supplier dependent
Access Times (typical)	supplier dependent	supplier dependent	supplier dependent	supplier dependent
Maximum Data Transfer Rates				
Writes	6X BD/16x DVD/40x CD	6x BD/16x DVD/40x CD	6X BD/8x DVD/24x CD	6X BD/8x DVD/24x CD
Reads	8X BD/16x DVD/40x CD	8x BD/16x DVD/40x CD	6X BD/8x DVD/ 24x CD	6X BD/8x DVD/ 24x CD
Power Source				
DC Power Requirements	12V, 5V	12V, 5V	5V	5V
DC Current	1200mA (12V)/ 900mA (5V)	1200mA (12V)/ 900mA (5V)	900mA	900mA
Environmental Operating Conditions (Non-Condensing):				
Operating Temperature Range	5°C to 50°C	5°C to 50°C	5°C to 50°C	5°C to 50°C
Relative Humidity Range	20% to 80% RH	20% to 80% RH	20% to 80% RH	20% to 80% RH
Maximum Wet Bulb Temperature	29°C	29°C	29°C	29°C
Altitude Range	-200 to 3048m	-200 to 3048m	-200 to 3048m	-200 to 3048m
Environmental Non-Operating Conditions (Non-Condensing):				
Operating Temperature Range	-40°C to 65°C	-40°C to 65°C	-40°C to 65°C	-40°C to 65°C
Relative Humidity Range	5% to 95% RH	5% to 95% RH	5% to 95% RH	5% to 95% RH
Maximum Wet Bulb Temperature	38°C	38°C	38°C	38°C
Altitude Range	-200 to 10600m	-200 to 10600m	-200 to 10600m	-200 to 10600m

OPTICAL DRIVES (CONT.)

DVD +/- RW ¹	MT	DT	SFF	USFF
External Dimensions inches/centimeters (Without Bezel – W x H x D)	148.2mm(6in)/42mm (2in)/ 171 (max)	148.2mm(6in)/42mm (2in)/ 171 (max)	128.0 mm (5.04)/ 12.7mm (0.5 in)/ 126.1mm (4.97in)	128.0 mm (5.04)/ 12.7mm (0.5 in)/ 126.1mm (4.97in)
Weight (max) pounds/ kilograms	700g	700g	170g	170g
Interface type and speed	SATA 1.5Gbit/s	SATA 1.5Gbit/s	SATA 1.5Gbit/s	SATA 1.5Gbit/s
Disc Capacity	Standard	Standard	Standard	Standard
Internal buffer size	supplier dependent	supplier dependent	supplier dependent	supplier dependent
Access Times (typical)	supplier dependent	supplier dependent	supplier dependent	supplier dependent
Maximum Data Transfer Rates				
Writes	16x DVD/48x CD	16x DVD/48x CD	8x DVD/ 24x CD	8x DVD / 24x CD
Reads	16x DVD/48x CD	16x DVD/48x CD	8x DVD/ 24x CD	8x DVD/ 24x CD
Power Source				
DC Power Requirements	12V, 5V	12V, 5V	5V	5V
DC Current	1200mA (12V)/ 900mA (5V)	1200mA (12V)/ 900mA (5V)	1000mA	1000mA
Environmental Operating Conditions (Non-Condensing):				
Operating Temperature Range	5°C to 50°C	5°C to 50°C	5°C to 50°C	5°C to 50°C
Relative Humidity Range	20% to 80% RH	20% to 80% RH	20% to 80% RH	20% to 80% RH
Maximum Wet Bulb Temperature	29°C	29°C	29°C	29°C
Altitude Range	-200 to 3048	-200 to 3048	-200 to 3048	-200 to 3048
Environmental Non-Operating Conditions (Non-Condensing):				
Operating Temperature Range	-40°C to 65°C	-40°C to 65°C	-40°C to 65°C	-40°C to 65°C
Relative Humidity Range	5% to 95% RH	5% to 95% RH	5% to 95% RH	5% to 95% RH
Maximum Wet Bulb Temperature	38°C	38°C	38°C	38°C
Altitude Range	-200 to 10600m	-200 to 10600m	-200 to 10600m	-200 to 10600m

¹ Discs burned with this drive may not be compatible with some existing drives and players; using DVD+R media provides maximum compatibility.

DVD-ROM	MT	DT	SFF	USFF
External Dimensions inches/centimeters (Without Bezel – W x H x D)	148.2mm(6in)/42mm (2in)/ 170 (max)	148.2mm(6in)/42mm (2in)/ 170 (max)	128.0 mm (5.04)/ 12.7mm (0.5 in)/ 126.1mm (4.97in)	128.0 mm (5.04)/ 12.7mm (0.5 in)/ 126.1mm (4.97in)
Weight (max) pounds/ kilograms	700g	700g	165g	165g
Interface type and speed	SATA 1.5Gbit/s	SATA 1.5Gbit/s	SATA 1.5Gbit/s	SATA 1.5Gbit/s
Disc Capacity	Standard	Standard	Standard	Standard
Internal buffer size	supplier dependent	supplier dependent	supplier dependent	supplier dependent
Access Times (typical)	supplier dependent	supplier dependent	supplier dependent	supplier dependent
Maximum Data Transfer Rates				
Writes	N/A	N/A	N/A	N/A
Reads	16x DVD/48x CD	16x DVD/48x CD	8x DVD/ 24x CD	8x DVD/ 24x CD

OPTICAL DRIVES (CONT.)

DVD-ROM (CONT.)	MT	DT	SFF	USFF
Power Source				
DC Power Requirements	12V, 5V	12V, 5V	5V	5V
DC Current	1200mA (12V)/ 900mA (5V)	1200mA (12V)/ 900mA (5V)	800mA	800mA
Environmental Operating Conditions (Non-Condensing):				
Operating Temperature Range	5°C to 50°C	5°C to 50°C	5°C to 50°C	5°C to 50°C
Relative Humidity Range	20% to 80% RH	20% to 80% RH	20% to 80% RH	20% to 80% RH
Maximum Wet Bulb Temperature	29°C	29°C	29°C	29°C
Altitude Range	-200 to 3048m	-200 to 3048m	-200 to 3048m	-200 to 3048m
Environmental Non-Operating Conditions (Non-Condensing):				
Operating Temperature Range	-40°C to 65°C	-40°C to 65°C	-40°C to 65°C	-40°C to 65°C
Relative Humidity Range	5% to 95% RH	5% to 95% RH	5% to 95% RH	5% to 95% RH
Maximum Wet Bulb Temperature	38°C	38°C	38°C	38°C
Altitude Range	-200 to 10600m	-200 to 10600m	-200 to 10600m	-200 to 10600m

MEDIA CARD READER (MCR)

NOTE: Dell 19 in 1 Media Card Reader (MCR) is supported via a F5 to F3 bay converter on the MT and DT and may require a slim line optical drive depending on selectable configuration. MCR is not available on the SFF and USFF chassis.

19 IN 1 MEDIA CARD READER	MT/DT
External Dimensions inches/(centimeters) (With Bezel – W x H)	3.99/(10.13cm)/1.0/(2.54cm)
Weight (max) pounds/kilograms	~155g
Interface type and speed	USB 2.0, 480Mb/s
Media Supported (maximum capacity supported will vary by Flash Media Types)	
Media Supported	CF I CF II Micro Drive (MD) Secure Digital (SD) SDHC Mini Secure Digital (mini-SD) Micro Secure Digital (Micro-SD)(with adapter) Multi Media Card (MMC) RS Multi Media Card (RS-MMC) Multi Media Card plus (MMC plus) RS Multi Media Card plus (RS-MMC plus) Multi Media Card Micro(MMC Micro) (with adapter) Memory Stick (MS) Memory Stick Pro(MS Pro) Memory Stick Pro Duo (MS Pro Duo) Memory Stick Duo (MS-Duo) Memory Stick Micro(MS Micro)(M2) (with adapter) Smart Media (SM) xD
Support Specification Versions:	Compact Flash type I/II Version 4.0 Smart Media (SM) Specification 2003 Multi Media Card (MMC) Specification 4.2 Secure Digital (SD) 2.0 Memory Stick Pro (MS-PRO) Specification 1.02 Memory Stick (MS) Specification 1.43 xD Specification 1.2
Power Source	
Max Power Requirements	2.5W
Supply Voltage Range	4.75V ~ 5.25V
Power Consumption:	Standby less than 0.5mA @ 5.0VDC
Environmental Operating Conditions (Non-Condensing):	
Operating Temperature Range	5°C to 50°C
Relative Humidity Range	10% to 90% RH
Environmental Non-Operating Conditions (Non-Condensing):	
Operating Temperature Range	-40°C to 65°C
Relative Humidity Range	5% to 95% RH

BIOS DEFAULTS

System Configuration	Integrated NIC:	Enable w/PXE
	Serial Port:	COM1
	SATA Operation:	RAID On
	Drives:	Enable (SATA-0, SATA-1, SATA-2, SATA-3)
	SMART Reporting:	Disable
	USB Configuration:	Enable (Boot Support, Front USB Ports, Rear Dual USB Ports, Rear Quad USB Ports)
	Miscellaneous Devices:	Enable (PCI Slot)
Video	Multi-display:	Disable (For system with discrete graphics)
Security	Strong Password:	Disable
	Password Configuration:	4~32
	Password Bypass	Disable
	Password Changes:	Enable
	TPM Security:	Disable
	Computrace®:	Deactivate
	CPU XD Support:	Enable
	OROM Keyboard Access	Enable
	Admin Setup Lockout	Disable
	Chassis Intrusion	Disable (For system with Chassis Intrusion detection)
Performance	Multiple Core Support:	All
	Intel® SpeedStep™:	Enable
	C States Control:	Enable
	Intel TurboBoost	Enable
	HyperThread control:	Enable
	HDD Protection Support	Enable (For China market only)
Power Management	AC Recovery:	Power Off
	Auto On Time:	Disable
	Deep Sleep Control:	Disable
	Fan Control Override:	Disable
	USB Wake Support	Disable
	Wake on LAN/WLAN:	Disable
	Block sleep	Disable
POST Behavior	Numlock LED:	Enable
	Keyboard Errors:	Enable
	POST HotKeys:	Enable
Virtualization Support	Virtualization:	Enable
	VT for Direct I/O:	Enable
	Trusted Direct I/O	Disable
Maintenance	Service Tag:	Set by the factory
	Asset Tag:	Optional User Entry
	SERR Message:	Enable

CHASSIS ENCLOSURE & VENTILATION REQUIREMENTS

ENCLOSURE VENTILATION

If your enclosure has doors, they need to be of a type that allows at least 30% airflow through the enclosure (front and back).

ENCLOSURE MINIMUM CLEARANCE

Leave a 10.2 cm (4 in.) minimum clearance on all vented sides of the computer to permit the airflow required for proper ventilation.

RECOMMENDED ENCLOSURE

Do not install your computer in an enclosure that does not allow airflow. This restricts the airflow and impacts your computer's performance, possibly causing it to overheat.

OPEN DESK MINIMUM CLEARANCE

If your computer is installed in a corner, on a desk, or under a desk, leave at least 5.1 cm (2 in.) clearance from the back of the computer to the wall to permit the airflow required for proper ventilation.



REGULATORY COMPLIANCE AND ENVIRONMENTAL

Product related conformity assessment and regulatory authorizations including Product Safety, Electromagnetic Compatibility (EMC), Ergonomics, and Communication Devices relevant to this product may be viewed at www.dell.com/regulatory_compliance. The Regulatory Datasheet for this product is located at http://www.dell.com/regulatory_compliance.

Details of Dell's environmental stewardship program to conserve product energy consumption, reduce or eliminate materials for disposal, prolong product life span and provide effective and convenient equipment recovery solutions may be viewed at www.dell.com/environment. Product related conformity assessment, regulatory authorizations, and information encompassing Environmental, Energy Consumption, Noise Emissions, Product Materials Information, Packaging, Batteries, and Recycling relevant to this product may be viewed by clicking the Design for Environment link on the webpage.

ACOUSTIC NOISE EMISSION INFORMATION**OPTIPLEX 9010 MT**

Component	Typical Configuration	High-end Configuration
CPU	Ivy Bridge i5 3470	Ivy Bridge i5 3770
Memory	4G DDR3 1600MHz	8G DDR3 1600MHz(x2)
HDD (#, capacity)	500G 7200RPM SATA3	1T 7200RPM SATA3(x2)
RMSD	16X DVD+/-RW SATA HH	16X DVD+/-RW SATA HH
Graphics Adapter	Intel® HD Graphics Family	ATI Radeon HD7570

The Declared Noise Emission in accordance with ISO 9296 for the Dell OptiPlex 9010 MT is as follows:
(all values L_{WAd} expressed in bels; 1 bel=10 decibels, re 10^{-12} Watts)

Operating Mode	Typical Configuration Declared Sound Power (L_{WAd})	High-end Configuration Declared Sound Power (L_{WAd})
Idle	4.0	4.3
HDD Operating	4.0	4.4
90% CPU	4.0	4.8
ODD Operating	5.2	5.2

The Declared A-weighted Sound Pressure Level in decibels (re 2×10^{-5} Pa), at Operator, Bystander, and Desk Side Positions are measured in accordance with ISO 7779 7.6.1, 7.6.2, and C.15.2 and declared in accordance with ISO 9296 for this product is as follows¹:

Operating Mode	Typical Configuration Declared Sound Pressure (LpA)				High-end Configuration Declared Sound Pressure (LpA)			
	Table-Top		Floor-Standing		Table-Top		Floor- Standing	
	Operator Position (LpA)	Bystander Position (LpA)	Operator Position (LpA)	Bystander Position (LpA)	Operator Position (LpA)	Bystander Position (LpA)	Operator Position (LpA)	Bystander Position (LpA)
Idle	29.4	25.3	23.2	22.1	35.9	33.6	24.7	24.3
HDD Operating	29.5	25.7	23.6	22.2	36.9	34.7	25.4	24.5
90% CPU	30.3	26.9	23.9	22.7	37.5	35.9	26.9	26.8
ODD Operating	42.7	39.6	36.6	35.4	42.7	40.1	37.1	34.7

¹ All tests are conducted according to ISO 7779 and declared according to ISO 9296 except 90% CPU. For this mode, the system CPU was stressed at 90% utilization with no other peripheral device actively seeking. This test mode is not specified in ISO 7779, but was measured using the same microphone distances and measurement techniques defined for the other reported operating modes.

² Declared Sound Power rounded to nearest tenth of a bel per ISO 9296 section 4.4.2

ACOUSTIC NOISE EMISSION INFORMATION

OPTIPLEX 9010 DT

Component	Typical Configuration	High-end Configuration
CPU	Ivy Bridge i5 3470	Ivy Bridge i5 3770
Memory	4G DDR3 1600MHz	8G DDR3 1600MHz(x2)
HDD (#, capacity)	500G 7200RPM SATA3	1T 7200RPM SATA3
RMSD	16X DVD+/-RW SATA HH	16X DVD+/-RW SATA HH
Graphics Adapter	Intel® HD Graphics Family	ATI Radeon HD7570

The Declared Noise Emission in accordance with ISO 9296 for the Dell OptiPlex 9010 DT is as follows:
(all values L_{WAd} expressed in bels; 1 bel=10 decibels, re 10^{-12} Watts)

Operating Mode	Typical Configuration Declared Sound Power (L_{WAd})	High-end Configuration Declared Sound Power (L_{WAd})
Idle	3.4	3.9
HDD Operating	3.4	4.0
90% CPU	3.6	4.2
ODD Operating	5.1	5.2

The Declared A-weighted Sound Pressure Level in decibels (re 2×10^{-5} Pa), at Operator, Bystander, and Desk Side Positions are measured in accordance with ISO 7779 7.6.1, 7.6.2, and C.15.2 and declared in accordance with ISO 9296 for this product is as follows¹:

Operating Mode	Typical Configuration Declared Sound Pressure (LpA)				High-end Configuration Declared Sound Pressure (LpA)			
	Table-Top		Floor-Standing		Table-Top		Floor- Standing	
	Operator Position (LpA)	Bystander Position (LpA)	Operator Position (LpA)	Bystander Position (LpA)	Operator Position (LpA)	Bystander Position (LpA)	Operator Position (LpA)	Bystander Position (LpA)
Idle	22.5	20.1	19.8	19.1	25.2	23.1	22.0	21.1
HDD Operating	22.7	20.0	19.5	19.2	25.4	23.5	21.9	20.9
90% CPU	23.9	22.2	24.6	23.5	32.6	30.2	25.7	25.2
ODD Operating	44.5	39.3	36.3	35.1	44.5	39.5	37.2	35.4

¹ All tests are conducted according to ISO 7779 and declared according to ISO 9296 except 90% CPU. For this mode, the system CPU was stressed at 90% utilization with no other peripheral device actively seeking. This test mode is not specified in ISO 7779, but was measured using the same microphone distances and measurement techniques defined for the other reported operating modes.

² Declared Sound Power rounded to nearest tenth of a bel per ISO 9296 section 4.4.2

ACOUSTIC NOISE EMISSION INFORMATION

OPTIPLEX 9010 SFF

Component	Typical Configuration	High-end Configuration
CPU	Ivy Bridge i5 3470	Ivy Bridge i5 3770
Memory	4G DDR3 1600MHz	8G DDR3 1600MHz(x2)
HDD (#, capacity)	500G 7200RPM SATA3	1T 7200RPM SATA3
RMSD	8X 12.7 SATA DVDRW	8X 12.7 SATA DVDRW
Graphics Adapter	Intel® HD Graphics Family	ATI Radeon HD7570

The Declared Noise Emission in accordance with ISO 9296 for the Dell OptiPlex 9010 SFF is as follows:
(all values L_{WAd} expressed in bels; 1 bel=10 decibels, re 10^{-12} Watts)

Operating Mode	Typical Configuration Declared Sound Power (L_{WAd})	High-end Configuration Declared Sound Power (L_{WAd})
Idle	3.9	4.3
HDD Operating	3.9	4.3
90% CPU	3.9	4.4
ODD Operating	4.8	4.8

The Declared A-weighted Sound Pressure Level in decibels (re 2×10^{-5} Pa), at Operator, Bystander, and Desk Side Positions are measured in accordance with ISO 7779 7.6.1, 7.6.2, and C.15.2 and declared in accordance with ISO 9296 for this product is as follows¹:

Operating Mode	Typical Configuration Declared Sound Pressure (LpA)				High-end Configuration Declared Sound Pressure (LpA)			
	Table-Top		Floor-Standing		Table-Top		Floor- Standing	
	Operator Position (LpA)	Bystander Position (LpA)	Operator Position (LpA)	Bystander Position (LpA)	Operator Position (LpA)	Bystander Position (LpA)	Operator Position (LpA)	Bystander Position (LpA)
Idle	30.2	25.5	25.2	24.5	31.1	27.2	26.2	25.7
HDD Operating	30.3	25.8	25.5	24.9	31.4	27.5	26.1	25.8
90% CPU	33.1	29.2	26.9	26.0	34.3	30.7	28.9	28.5
ODD Operating	36.5	32.7	30.9	29.9	37.7	32.9	32.9	32.1

¹ All tests are conducted according to ISO 7779 and declared according to ISO 9296 except 90% CPU. For this mode, the system CPU was stressed at 90% utilization with no other peripheral device actively seeking. This test mode is not specified in ISO 7779, but was measured using the same microphone distances and measurement techniques defined for the other reported operating modes.

² Declared Sound Power rounded to nearest tenth of a bel per ISO 9296 section 4.4.2

ACOUSTIC NOISE EMISSION INFORMATION**OPTIPLEX 9010 USFF**

Component	Typical Configuration
CPU	Ivy Bridge i5 3470
Memory	4G DDR3 1600MHz
HDD (#, capacity)	500G 7200RPM SATA2
RMSD	8X 12.7 SATA DVDRW
Graphics Adapter	Intel® HD Graphics Family

The Declared Noise Emission in accordance with ISO 9296 for the Dell Optiplex 9010 USFF is as follows:
(all values L_{WAd} expressed in bels; 1 bel=10 decibels, re 10^{-12} Watts)

Operating Mode	Typical Configuration Declared Sound Power (L_{WAd})
Idle	3.9
HDD Operating	3.9
90% CPU	4.8
ODD Operating	4.7

The Declared A-weighted Sound Pressure Level in decibels (re 2×10^{-5} Pa), at Operator, Bystander, and Desk Side Positions are measured in accordance with ISO 7779 7.6.1, 7.6.2, and C.15.2 and declared in accordance with ISO 9296 for this product is as follows¹:

Operating Mode	Typical Configuration Declared Sound Pressure (LpA)			
	Table-Top		Floor-Standing	
	Operator Position (LpA)	Bystander Position (LpA)	Operator Position (LpA)	Bystander Position (LpA)
Idle	28.5	25.4	22.9	21.6
HDD Operating	28.6	25.6	22.9	21.7
90% CPU	28.9	25.8	23.8	21.9
ODD Operating	40.3	35.9	32.5	29.9

¹ All tests are conducted according to ISO 7779 and declared according to ISO 9296 except 90% CPU. For this mode, the system CPU was stressed at 90% utilization with no other peripheral device actively seeking. This test mode is not specified in ISO 7779, but was measured using the same microphone distances and measurement techniques defined for the other reported operating modes.

² Declared Sound Power rounded to nearest tenth of a bel per ISO 9296 section 4.4.2